

NEW AQUAREA RANGE 2017 – 2018  
HIGH-EFFICIENCY HEAT  
PUMP TECHNOLOGY

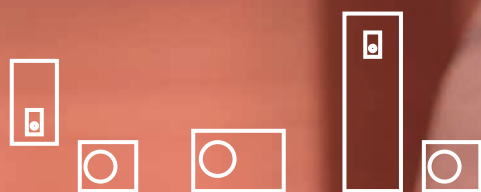

# AQUAREA RANGE NEW 2017 — 2018

## Index

THE LAST GENERATION OF AIR CONDITIONING.....	4	AQUAREA ALL IN ONE H GENERATION HIGH PERFORMANCE BI-BLOC SINGLE PHASE / THREE PHASE. HEATING AND COOLING. 1 ZONE HYDROKIT OR 2 ZONES BUILT-IN HYDROKIT.....	42
A GLOBALLY TRUSTED AIR CONDITIONING BRAND.....	6	AQUAREA ALL IN ONE H GENERATION T-CAP BI-BLOC SINGLE PHASE / THREE PHASE. HEATING AND COOLING.....	43
100% PANASONIC, THE DNA OF JAPANESE CRAFTSMANSHIP.....	8	AQUAREA ALL IN ONE HIGH PERFORMANCE BI-BLOC SINGLE PHASE / THREE PHASE. HEATING AND COOLING.....	44
PANASONIC: ECO & SMART IDEAS FOR A SUSTAINABLE LIFESTYLE.....	10	AQUAREA ALL IN ONE T-CAP BI-BLOC SINGLE PHASE. HEATING AND COOLING.....	45
PROJECTS & CASE STUDIES OF PANASONIC HEATING AND COOLING SOLUTIONS.....	12	AQUAREA H GENERATION HIGH PERFORMANCE BI-BLOC SINGLE PHASE / THREE PHASE. HEATING AND COOLING - SDC.....	46
PRO CLUB. THE PROFESSIONAL WEBSITE OF PANASONIC.....	14	AQUAREA H GENERATION T-CAP BI-BLOC SINGLE PHASE / THREE PHASE. HEATING AND COOLING - SXC.....	47
AQUAREA DESIGNER.....	15	AQUAREA H GENERATION T-CAP BI-BLOC THREE PHASE. SUPER QUIET OUTDOOR UNIT. HEATING AND COOLING - SXC.....	48
WELCOME TO AQUAREA AIR TO WATER HEAT PUMP.....	16	AQUAREA HT BI-BLOC SINGLE PHASE / THREE PHASE. HEATING ONLY - SHF.....	49
HIGHLIGHTED FEATURES.....	18	AQUAREA H GENERATION HIGH PERFORMANCE MONO-BLOC SINGLE PHASE. HEATING AND COOLING - MDC.....	50
HOW DO YOU GET HEATING AND DOMESTIC HOT WATER FROM AIR?.....	20	AQUAREA G GENERATION HIGH PERFORMANCE MONO-BLOC SINGLE PHASE. HEATING AND COOLING - MDC.....	51
AQUAREA HEAT PUMP LINE-UP.....	22	AQUAREA G GENERATION T-CAP MONO-BLOC SINGLE PHASE / THREE PHASE. HEATING AND COOLING - MXC.....	52
NEW AQUAREA H GENERATION A+++.....	24	AQUAREA G GENERATION HT MONO-BLOC SINGLE PHASE. HEATING ONLY - MHF.....	53
AQUAREA HIGH PERFORMANCE.....	26	AQUAREA AIR RADIATORS FAN COILS FOR HEAT PUMP APPLICATION.....	54
AQUAREA T-CAP.....	28	SANITARY TANKS.....	56
AQUAREA HT.....	30	AQUAREA DHW.....	58
AQUAREA COMMERCIAL.....	32	ACCESSORIES & CONTROL.....	60
NEW AQUAREA SMART CLOUD FOR H GENERATION.....	34	PANASONIC'S AQUAREA OFFERS THE BEST FOR YOU AND YOUR HOME.....	62
CONTROL & CONNECTIVITY.....	35	HEATING & COOLING CAPACITY TABLES.....	64
REMOTE CONTROLLER.....	36	EXAMPLES OF INSTALLATIONS.....	74
HEAT PUMP MANAGER.....	37	DIMENSIONS.....	75
AQUAREA + PV PANELS.....	38		
AQUAREA HEAT PUMPS LINE-UP.....	40		

## New Aquarea H Generation A+++

The beauty of comfort. The new H Generation is being introduced ranging from 3 to 16kW. The small capacity units are specially designed for low energy homes and achieve an impressive COP of 5 (on the 3kW).



## New All in One H Generation

The new All in One solution from 3 to 16kW with 200L stainless tank with free maintenance. The "A" class pump provides a small foot print and ideal solution for new, retrofit homes.

## DHW tank with built-in Heat Pump

The Heat Pump is one of the most energy efficient and cost effective methods of water heating. The pump is mounted on the storage tank and draws energy from the ambient air, using that extra energy source to heat the water up to 55°C.



## New Mono-Bloc Generation

The "A" class water pump equipped with the new remote controller maximises savings while improving the performance and comfort.

## New Aquarea Smart Cloud

The Aquarea Smart Cloud is a powerful and intuitive service for remotely controlling the full range of heating and hot water functions, including monitoring energy consumption.



### Quality Management System Certificate



### Environmental Management System Certificate



# THE LAST GENERATION OF AIR CONDITIONING



Panasonic is committed to creating a better life and a better world thanks to its breakthrough technology, continuously contributing to the evolution of society and to the happiness of people around the globe.



### Constantly Improving

At Panasonic, we know that the best is always yet to come. This is why our air conditioning and heat pump solutions are constantly upgraded. We are always looking to improve our technology; finding the most efficient solutions that save our customers money. Our Technology & Design teams anticipate the needs of tomorrow. We look to produce smaller, quieter, efficient solutions - with better technological features - that can reduce energy consumption while providing suitable temperature conditions for the user.

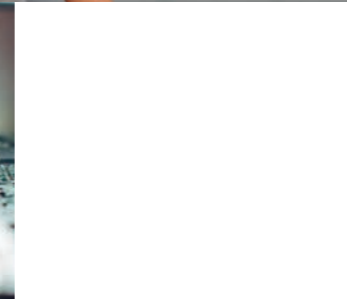
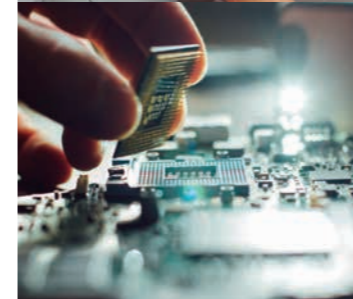
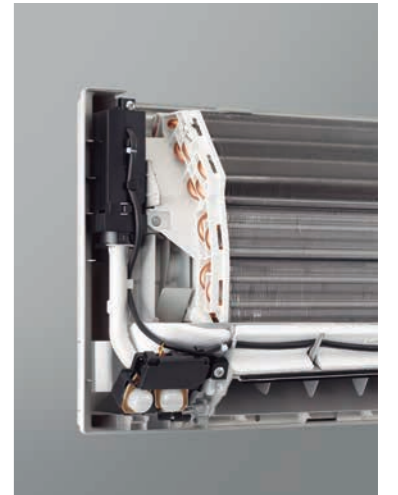

### Look ahead to the "Future," keep taking on challenges

Starting 1918, Panasonic has constantly added to its guarantee for innovation, taking tomorrow's technologies and applying them to today's needs. Always making "people" central to our activities, and thereby focusing on "people's lives," we will continue to provide better living for our customers. This is the unchanging commitment we at Panasonic have had over many years. We are aiming for now is to expand our contribution to "better living" everywhere. This means that in the variety of spaces where our customers go about their lives, ranging from inside the home, the office, the store, the automobile, and the airplane, as well as the town, we will provide not only single pieces of hardware,

but also total solutions including software and services. We will pursue the concept of "A Better Life, A Better World," meeting the needs of each individual customer.

To that end, we will leverage the strengths that we at Panasonic have long developed in our consumer electronics business, the strengths of our business partners who have in-depth expertise in many areas, and will work to combine these strengths by pursuing "Cross-Value Innovation." In this way, we will create new value. This is the new and challenging task we are now addressing.

# A GLOBALLY TRUSTED AIR CONDITIONING BRAND



Testing laboratory Panasonic Gunma, Japan (PAPARS).

Panasonic – leading the way in Heating and Cooling. With more than 30 years of experience, selling to more than 120 countries around the world, Panasonic is unquestionably one of the leaders in the heating and cooling sector.

With a diverse network of production and R&D facilities, Panasonic delivers innovative products incorporating cutting-edge technologies that set the standard for air conditioners worldwide. Expanding globally, Panasonic provides superior international products transcending borders.



### 100% Panasonic: we control the process

The company is also a world leader in innovation as it has filed more than 91,539 patents to improve its customers' lives. Moreover, Panasonic is determined to remain at the forefront of its market. In all, the company has produced more than 200 million compressors and its products are manufactured in 294 plants which are located all over the world. You can be assured of the extremely high quality of Panasonic's heat pumps. This wish to excel has made Panasonic the international leader in heating and turn-key air conditioning solutions. These offer maximum effectiveness, comply with the strictest environmental standards and meet the most avant-garde construction requirements of our time.

### History of Air Conditioning Group

Panasonic starts with a desire to create things of value. As hard work and dedication results in one innovative product after another, the new company took its first steps towards becoming the electronics giant of today.

Heating and Cooling Solutions designed and produced by Panasonic since 1958. See more information on [www.aircon.panasonic.eu](http://www.aircon.panasonic.eu)



**1958**  
First room air conditioner launched for domestic installation.

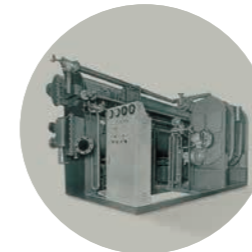

**1971**  
Starts production of absorption chillers.



**1973**  
Panasonic launches the first highly efficient air-to-water heat pump in Japan.



**1975**  
Panasonic becomes the first Japanese air conditioner manufacturer in Europe.



**1985**  
Introduces first GHP (gas heat pump) VRF air conditioner.



**1989**  
Introduces world's first simultaneous 3-Pipe heating/cooling VRF system.



**2008**  
Etherea new concept of air conditioning systems: high efficiency and high performances with a great design.



**2010**  
New Aquarea. Panasonic has created Aquarea, an innovative new, low-energy system.



**2012**  
New GHP units. Panasonic's gas-driven VRF systems are ideal for projects where power restrictions apply.



**Looking ahead**  
New VRF Systems ECOi EX with Extraordinary Energy-Saving Performance and Powerful Operation EER 4.7.

# 100% PANASONIC, THE DNA OF JAPANESE CRAFTSMANSHIP

JAPAN  
QUALITY



Applying advanced technologies that truly make life better, we live by an unparalleled commitment to product quality. Panasonic is building on the Japanese tradition of uncompromising quality control worldwide, developing and manufacturing fine products and delivering them to customers everywhere.

At Panasonic, we believe that the best air conditioner is one that works quietly and effectively in the background whilst minimising its impact on the environment

People who use our products can look forward to long years of high-quality performance without the need for constant service. As part of our rigorous design and development process, Panasonic air conditioners undergo a variety of stringent tests to ensure their effectiveness and long-term reliability. Tests for durability, waterproofing, shock resistance, and noise are conducted on component parts or on the finished products themselves.

As a result of all of these time consuming efforts, Panasonic air conditioners meet even the most demanding industrial standards and regulations in every country where they are sold.

## International Standard Quality

To uphold the company's reputation around the world, Panasonic strives continuously to offer the highest quality with the lowest possible environmental impact.



### Reliable parts that meet or exceed industrial standards

In every country where they are sold, Panasonic air conditioners comply with all required industrial standards and regulations. In addition, Panasonic conducts stringent testing to ensure the reliability of parts and materials. The strength of the resin material used in a propeller fan is confirmed by a tension test.



### RoHS / REACH compliant parts

All Panasonic parts and materials comply with Europe's strict RoHS/REACH environmental regulations. During the development and production of parts, stringent inspections are conducted on over 100 materials to ensure that no hazardous substances are included.



### Sophisticated production process

Panasonic's air conditioner production lines employ state-of-the-art factory automation technologies to ensure products are manufactured efficiently and with uniformly high levels of quality and reliability.

## Durability

At Panasonic we know the importance of a long service life with minimal maintenance. That's why we subject our air conditioners to a wide range of stringent durability tests.



### Long-term durability test

To ensure durability and stable operation for many years, we conduct a long-term continuous operation test under conditions that are much more severe than actual operating conditions.



### Compressor reliability test

After the continuous operation test, we remove the compressor from a selected outdoor unit, disassemble it, and examine the internal mechanisms and parts for potential failure. This helps ensure reliable long-term performance under harsh conditions.

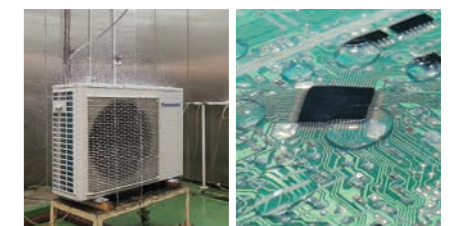

### Waterproofing test

The unit - which is subject to rain and wind - complies with IPX4 waterproof specifications. Contact sections on printed circuit boards are resin-potted to prevent adverse effects caused by exposure to water (an unlikely occurrence).

# PANASONIC: ECO & SMART IDEAS FOR A SUSTAINABLE LIFESTYLE



Panasonic Green Innovation Company.  
We will make the environment central to all our business activities and work to realise our vision with innovations for both every day life and business.



## Exemplary sustainable projects

### Fujisawa Sustainable Smart Town Goes Into Full-Scale Operation Near Tokyo

Fujisawa SST Council is a consortium led by Panasonic Corporation spearheading the development of the Fujisawa Sustainable Smart Town (Fujisawa SST). With its core facility supporting sustainable development of the town and its community now coming into operation, the Fujisawa SST is moving from the construction stage into a new stage where the town is nurtured to grow in full-scale into an eco and smart town that puts a high priority on the residents' lifestyles.

The Fujisawa SST Management Company is the town management company located in the SQUARE. Together with partner companies, the company provides five essential services in the town: energy, security, mobility, healthcare and community. The company will also collect and manage information relating to the town's overall environment, energy, security and safety to support an eco and smart life in the town.

As a fresh development in the town, the Fujisawa SST has set a detached housing zone for non car owners for the second phase of sales. By using the town's eco-car sharing and rent-a-car services, residents in the zone



can enjoy their lifestyles without the need to own a car while reducing economic burden and making effective use of the lot. Preparations are also underway for a new base to provide environmentally-friendly logistic services to the residents.

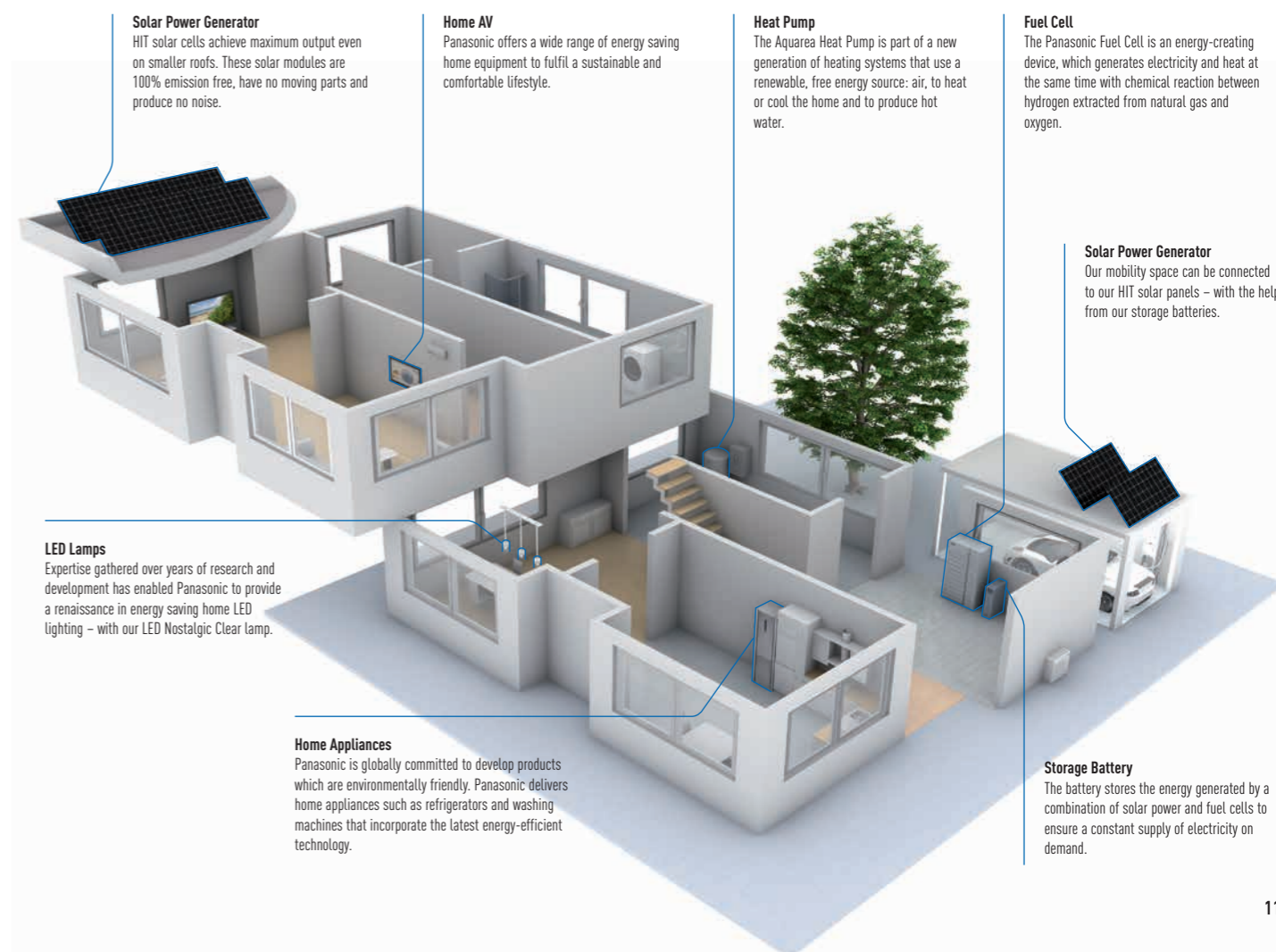

# PROJECTS & CASE STUDIES OF PANASONIC HEATING AND COOLING SOLUTIONS



New Hotel Monument 5\*GL is located in an 1896 palace. Barcelona, Spain. ECOi and E-Control

Panasonic, a partner with the knowledge and experience to achieve your objectives and green needs



Integrated technology that permits better work, easy installation, high efficiency performance, and energy saving.

Our main targets are the distributed services and B2B-integrated solutions.

Panasonic provides a single point of contact for the design and maintenance of your system, making things easy for you.

Given our experience in processes, technologies and complex business models, we can offer you effective solutions that reduce costs, whilst also being efficient, user-friendly, reliable and innovative.

Another advantage we offer to our clients is a support service for systems integration projects, which we provide through our wide range of services and solutions.

As a global company, we have at our disposal the financial, logistical and technical resources to develop complex and wide-ranging solutions, both at country and international level by implementing them both on-time and on-budget.



The latest glamorous Burger & Lobster restaurant in Bath. UK. **AQUAREA**



Brabrand Boligforening has constructed 75 low-energy houses in Hasselager near Århus **AQUAREA**



An water tower has been converted into a stunning family home. Yorkshire, UK. **AQUAREA**



21 of the 5-6 bedroom luxury homes in Straffan Co.Kildare, Ireland. **AQUAREA**



Duplex in Boves, CN. Italy. **AQUAREA**



Make the most of RHI. An off-grid, medium-sized property. Fife, Scotland. **AQUAREA**



77 house project in Latvia. **AQUAREA**



Passive House. Tychowo Poland. **AQUAREA**



A new building, housing 84 apartments in Cornellà de Llobregat, Barcelona. **AQUAREA**



Carluccios Restaurant in Sheffield. UK. **AQUAREA**



New Housing in Rossåsen, Norway. **AQUAREA**



Panasonic Smart Home. A house with zero emissions. Tokyo, Japan. **RAC-AQUAREA**

To find out more: [www.aircon.panasonic.eu](http://www.aircon.panasonic.eu)

# PRO CLUB. THE PROFESSIONAL WEBSITE OF PANASONIC



**PRO Club**  
 Download on [www.panasonicproclub.com](http://www.panasonicproclub.com)  
 or connect simply with your smartphone to the PRO Club using this QR

Panasonic PRO Club ([www.panasonicproclub.com](http://www.panasonicproclub.com)) is the online tool which makes your life easier! You just have to register and a lot of functionalities are freely available to you, where ever you are, from your computer or smart phone!

- Print catalogues with your logo and your address
- Download the latest Aquarea designer to define your system and select the good Aquarea Heat pump.
- Calculate the specs of the Aquarea Air fan coil based on the parameters of your system
- Get Documents of conformity and all other documents you may need
- Download all the service manuals, end user manuals and installation manuals
- Know what to do with error codes
- Find out about the latest news first
- Register for training

### Highlighted Features

- Extensive library of resources
- Tools & Apps for end users. Check availability in your country:
  - My Home: sizing wizard for domestic and AZW range
  - My Project: Contact form to Panasonic team
  - iFinder: Lists of installers displayed by postcode
- Special offers & promotions
- Training PRO Academy

- Catalogues (Commercial documentation)
- Marketing (Images in high resolution, advertisements, deco guidelines)
- Tools (Professional software, sizing tools...)
- Installers customize leaflets in PDF format with their logo & contact details
- Energy label generator. Download energy labels of any device in PDF format
- Heating calculator
- Noise calculator for outdoor unit
- Aquarea Radiator calculator
- Error Code Search by error code or unit ref. Compatible with smartphone and tablet computer
- Revit / CAD Images / Spec texts
- Access to Pananet, online library of technical documentation
- Download Documents of Conformity and other Certifications
- Commissioning online

**Panasonic PRO Club is fully compatible with tablet computer and smartphone.**

Panasonic has an impressive range of support services for designers, specifiers, engineers and distributors working in the heating and cooling markets.



Easy download Panasonic service documentation and brochures



Customise leaflets with your logo & contact details. Save and print the PDF



Energy label generator. Download Energy labels of any device in PDF format



Error Code on your smartphone and your PC: Search by error code or model reference. Online version + downloadable version for offline use

# AQUAREA DESIGNER



This program allows HVAC designers, installers and distributors to identify the correct heat pump for a particular application from Panasonic's Aquarea range, calculate the savings compared to other heat sources and very quickly calculate CO<sub>2</sub> emissions.

Using Panasonic's Aquarea Designer, projects can be developed simply and easily, by either using the Quick Design or Expert Design options. Each allows the user to build up the project data in a simple step-by-step process and choose to output reports (in either Quick or Large formats) as HTML files or as print-outs. To create these useful reports, project data is input, including:

- Heated area
- Heating requirement
- Heating flow and return temperatures
- Climate data (from a simple drop-down menu) including outdoor temperature
- Type of hot water tank, storage capacity and hot water target temperature

**Panasonic provides bespoke software helping system designers, installers and dealers to very quickly design and size systems, create wiring diagrams and issue bills of quantities at the push of a button.**

### The Panasonic PRO Academy

Panasonic takes its responsibility to its distributors, specifiers and installers seriously and has developed a comprehensive Training Programme. The Panasonic Pro-Academy encompasses the traditional hands-on approach to teaching.

New training courses cover three levels. Design, installation, and commissioning & trouble-shooting. Training courses include:

- Domestic applications Air to Air
- Aquarea air source heat pumps
- VRF ECOi

The courses are offered on site at Panasonic's premises across Europe. The Training Centres display Panasonic's latest product range and give delegates an opportunity to get a hands-on experience with the latest controllers, indoor and outdoor units from the VRF ECOi, Etherea, GHP and Aquarea ranges.



### Aquarea Designer also means saving

Aquarea Designer will calculate the project's energy costs in terms of hot water, heating and pumping. It will show the equipment running times and calculate the COP (coefficient of performance). It then allows the designer to show clients a comparison with other equipment options such as heating by conventional gas-fired boilers, oil systems, wood, standard electric heating and electric night storage heaters. This compares running costs, initial investment costs and maintenance costs. The comparison can also be made for CO<sub>2</sub> emissions and savings.



**PRO Club**  
 Download on [www.panasonicproclub.com](http://www.panasonicproclub.com)  
 or connect simply with your smartphone to the PRO Club using this QR



# WELCOME TO AQUAREA AIR TO WATER HEAT PUMP



Aquarea's new Air to Water Heat Pump for residential and commercial applications. Offering capacities from 3kW all the way through to 16kW, the Aquarea Heat Pump Range is the widest on the market, ensuring a system is available, whatever your heating and cooling needs. Suitable for new build and refurbishment projects, the solutions are cost-effective and environmentally friendly.



# HIGHLIGHTED FEATURES

# AQUAREA



Panasonic's Aquarea range of Heat Pumps deliver major energy savings thanks to its incredible efficiency even at -20°C. The Panasonic Aquarea Heat Pumps are designed and produced by Panasonic and not by other companies.

The Aquarea Heat Pump is a system that generates the perfect temperature and produces hot water, in an easy, cheap and environmentally friendly way, by transferring heat instead of generating it. It is among the Technologies listed on the International Energy Agency (IEA) Blue Map, whose goal is to reduce CO<sub>2</sub> emissions to half the levels emitted in 2005, by the year 2050.

Aquarea is part of a new generation of heating solutions that use a renewable, free energy source (the air) to heat or cool the home and to produce hot water:

- Extremely high efficiency (COP of 5,08 for new 5kW Mono-bloc unit)
- Line up developed for low consumption homes (starting at 3kW)
- T-CAP solution is ideal for cold areas, as it maintains the nominal capacity up to -15°C
- Easy to control with your smart phone (using an optional interface)
- Large range of efficient tanks for domestic hot water storage

## Energy saving



Better Efficiency & Value. For medium temperature applications. Aquarea systems meets ErP regulation as A++.



Better Efficiency & Value. For low temperature applications. Aquarea systems meets ErP regulation as A++.



Better Efficiency & Value. For low temperature applications. Aquarea systems meets ErP regulation as A.

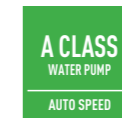

Aquarea are built-in with A class water pump. H Generation with auto speed, and F Generation and normal G Generation with 7 speeds.



The A Inverter+ system provides energy savings of up to 30% compared to non Inverter models. Both you, and nature, wins!

## High Performance

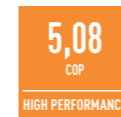

Aquarea High Performance for low consumption houses. From 3 to 16kW. For a house with low temperature radiators or under-floor heating, our high performance Aquarea HP is a good solution.



Aquarea T-CAP for extremely low temperatures. From 9 to 16kW. If the most important aspect is to maintain nominal heating capacities even at temperatures as low as -7°C or -15°C, select the Aquarea T-CAP.



Aquarea HT ideal for retrofit. From 9 to 12kW. For a house with traditional high-temperature radiators, the Aquarea HT solution is the most appropriate, can work in output water temperatures of 65°C even at outdoor temperatures as low as -20°C.



DHW. With Aquarea you can also heat your domestic hot water at a very low cost with the optional hot water cylinder.



Down to -20°C in heating mode. The Heat Pumps work in Heat Pump mode with an outdoor temperature as low as -20°C.



Water filter (easy access & fast clip technology) for H Generation.



Water stop valve included on H Generation.

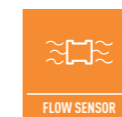

Water Flow Sensor included on H Generation.



We guarantee the outdoor unit compressors in the entire range for five years.



SG Ready: Thanks to Aquarea HPM, Aquarea range (Bi-bloc and Mono-bloc) is holding the SG Ready Label (Smart Grid Ready Label), given by Bundesverband Wärmepumpe (German Heat Pump Association). This Label shows the real capacity of Aquarea to be connected in an intelligent grid control. MCS Certificate number: MCS HP0086.\*

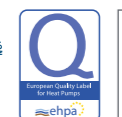

## High connectivity



Renovation. Our Aquarea Heat Pumps can be connected to an existing or new boiler for optimum comfort even at very low outdoor temperatures.



Solar Kit. For even greater efficiency, our Aquarea Heat Pumps can be connected to photovoltaic solar panels with an optional kit.



New remote controller with full dotted 3.5" wide back light screen. Menu with 10 available languages easy to use for installers and user. Included on H Generation.



Internet Control is a next generation system providing a user-friendly remote controller of air conditioning or Heat Pump units from everywhere, using a simple Android or iOS smartphone, tablet or PC via internet.

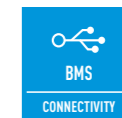

Connectivity. The communication port is integrated into the indoor unit and provides easy connection to, and control of, your Panasonic Heat Pump to your home or building management system.

\* Not all products certified. As the certification process is on-going and the list of certified products constantly changing, please check for latest details on the official websites.

# HOW DO YOU GET HEATING AND DOMESTIC HOT WATER FROM AIR?



New Aquarea Air to Water Heat Pump, the best seasonal efficiency. At the forefront of energy innovation, Aquarea is resolutely positioned as a “green” heating and air conditioning solution.

### Introducing the Panasonic Aquarea – Air Source Heat Pump

An Aquarea air source Heat Pump circulates fresh air and passes it over refrigerant-filled coils (like a refrigerator). The captured heat is automatically transferred to water, which is then ready for use in your heating system and for supplying all of your domestic hot water needs. Panasonic’s latest technology offers you a sustainable alternative to oil, LPG and electric heating systems.

### Up to 80% energy savings\*

At the forefront of energy innovation, Aquarea is resolutely positioned as a “green” heating and air-conditioning solution. Aquarea is part of a new generation of heating and air-conditioning solutions that use a renewable, free energy source – the air – to heat or cool the home and produce hot water. The Aquarea Heat Pump is a much more flexible and cost-effective alternative to a traditional fossil fuel boiler.

### “Green” High-efficiency heating with Panasonic’s new Air to Water Heat Pump Systems

Panasonic’s Aquarea Heat Pump provides savings of up to 80% on heating expenses compared to electrical heaters. For example, the Aquarea 5kW system has a COP of 5,28. This is 5,28 more than a conventional electrical heating system which has a maximum COP of 1. This is equivalent to an 80%\* saving. Consumption can be further reduced by connecting photovoltaic solar panels to the Aquarea system.

**Aquarea Air to Water Heat Pump: An innovative low energy solution, designed to create great comfort at home even at extreme outdoor temperatures. Providing heat to radiators, underfloor heating, fancoils as well as producing domestic hot water.**

### Why Air Source Heat Pumps?

- Heating, cooling and domestic hot water produced with a single system
- Best in terms of efficiency: even at extreme outdoor temperatures
- Environmentally friendly: can be connected to solar panels
- Technology that adapts to each home: extreme low temp, high temperature, whatever the climate
- Wide range of solutions: floor heating, radiators and fan coils
- Reduced heating bills and maintenance costs
- Reduce your carbon footprint
- Simple to integrate into existing heating systems
- Energy efficient alternative to oil, LPG and electric systems
- Ideal for properties without access to mains gas
- Externally positioned saving valuable internal living space

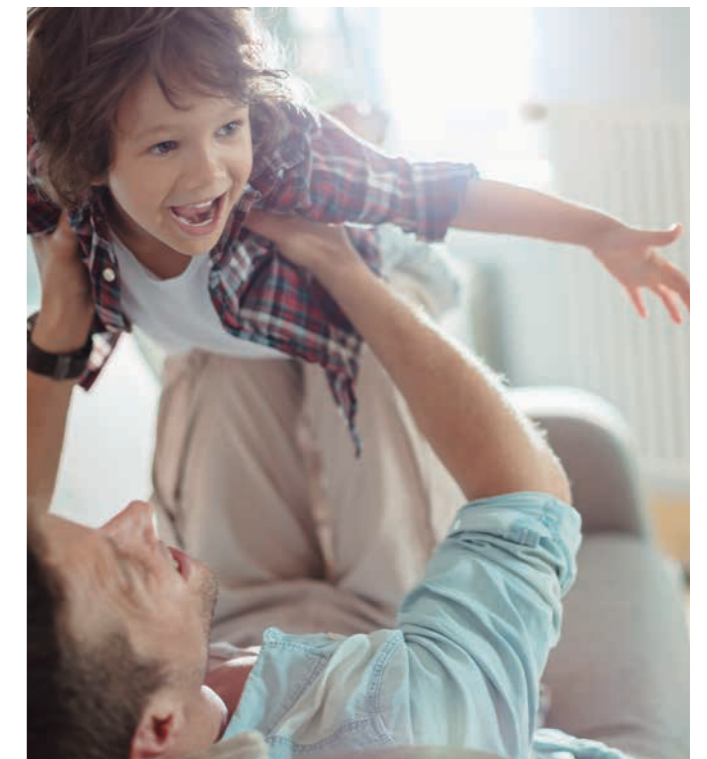

### Aquarea up to 80% energy savings\*

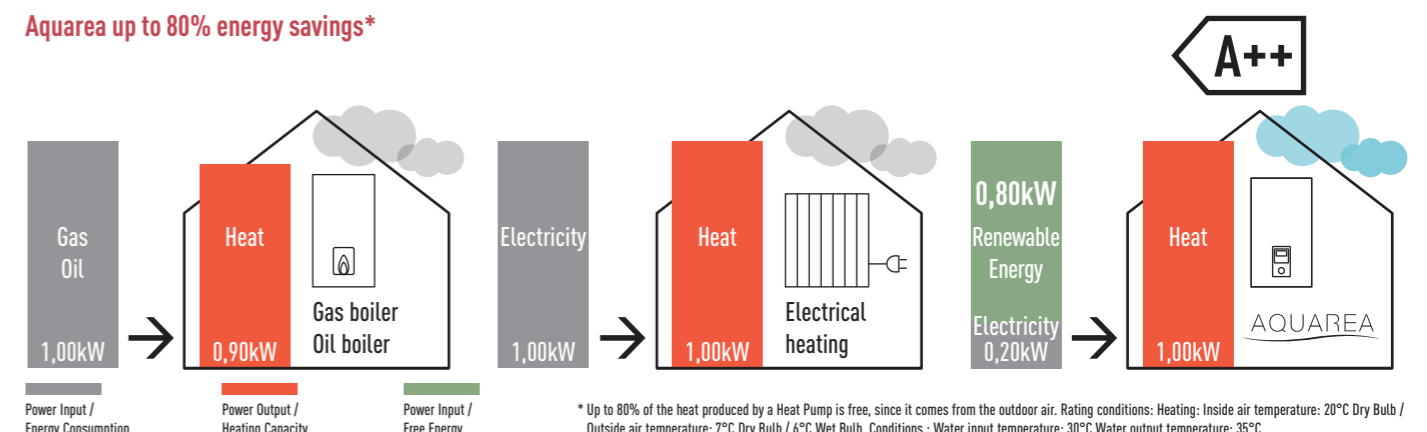

# AQUAREA HEAT PUMP LINE-UP

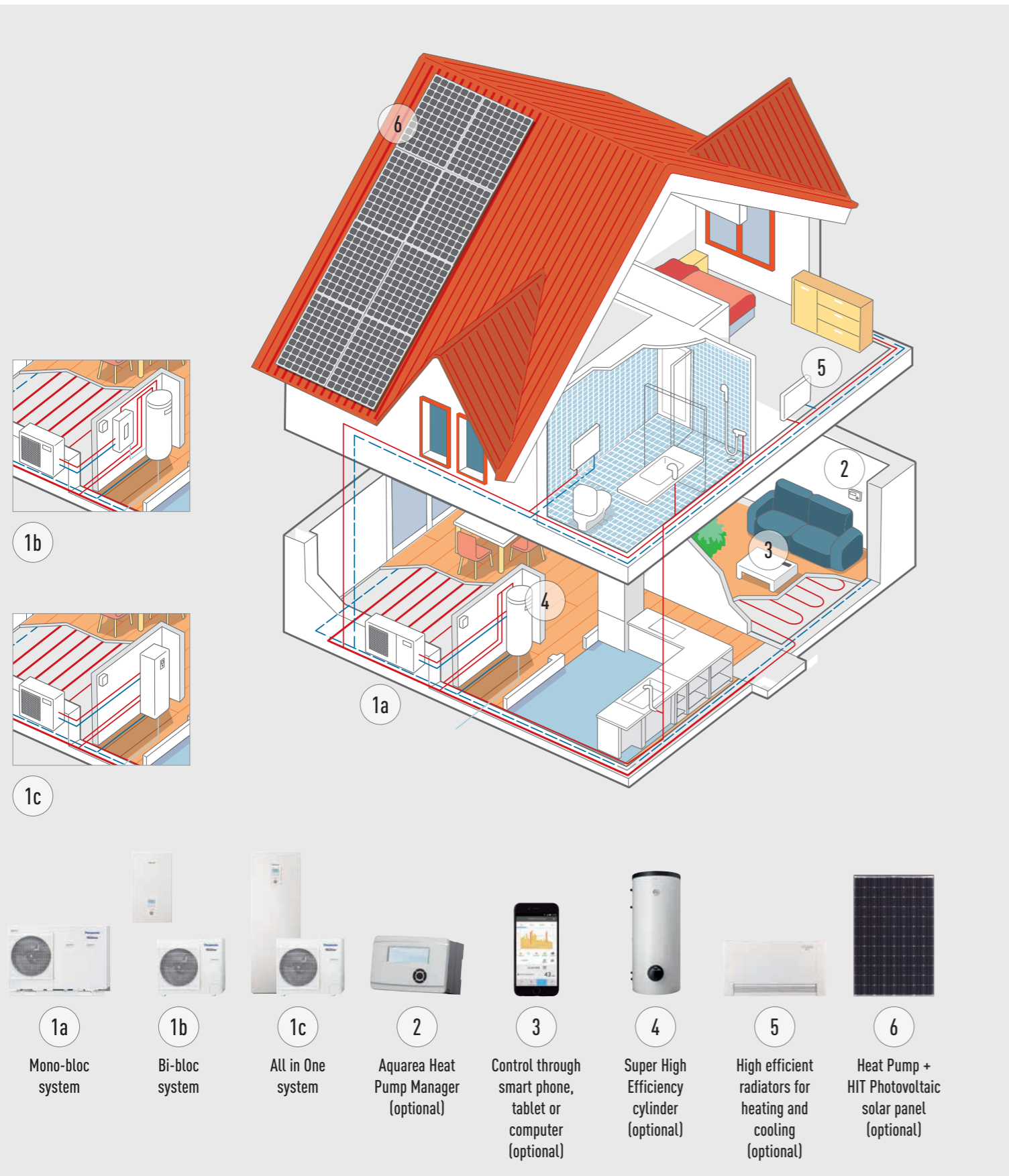

Panasonic Aquarea offers you solutions, helping to make the home more efficient and the installation cheaper and easier.

### Aquarea High Performance. For new installations and low consumption homes

Maximum savings, maximum efficiency, minimum CO<sub>2</sub> emissions, minimum of space. Improved performance with COP's up to 5,28.

### Aquarea T-CAP. For extremely low temperatures, refurbishment and innovation

Ideal to ensure that the heating capacity is maintained even at very low temperatures. This line-up is able to maintain the Heat Pump output capacity until -20°C outdoor temperature without the help of an electrical booster heater.

### Aquarea HT. For a house with old high-temperature radiators

Ideal for retrofit: green energy source works with existing radiators. Aquarea HT Solution is the most appropriate, provides output water temperatures of 65°C even at outdoor temperatures as low as -15°C.

### Aquarea DHW

DHW tank with built-in Heat Pump.

Aquarea High Performance	Aquarea T-CAP	Aquarea HT	Aquarea DHW
 Heating - Cooling - DHW Single Phase from 3 to 16kW Three Phase from 9 to 16kW	 Heating - Cooling - DHW Single Phase from 9 to 12kW Three Phase from 9 to 16kW	 Heating - DHW Single Phase from 9 to 12kW Three Phase from 9 to 16kW	 Only DHW From 80 to 295L
<b>Connectable to</b>			
<b>Application</b>			
<b>Energy efficiency</b>			
 Heating 35°C / 55°C	 Heating 35°C / 60°C <sup>1</sup>	 Heating 35°C / 55°C	 DHW 55°C
<b>Outdoor ambient temperature limit. Operation</b>			
-28°C	-28°C	-28°C	-7°C
<b>Outdoor ambient temperature limit. Constant capacity</b>			
	-15°C / -20°C <sup>1</sup>	-15°C	
<b>Supply temperature for heating. Max. / Heat pump only</b>			
75°C / 55°C	75°C / 60°C <sup>1</sup>	75°C / 65°C	75°C / 55°C
<b>Control and connectivity</b>			
Smart Grid Ready <sup>2</sup> Wifi Ready	Smart Grid Ready <sup>2</sup> Wifi Ready	Smart Grid Ready <sup>2</sup> Wifi Ready	Smart Grid Ready <sup>2</sup> Wifi Ready
<b>Range</b>			
Bi-bloc from 3 to 16kW Mono-bloc from 5 to 16kW All in One from 3 to 16kW (185L)	Bi-bloc from 9 to 16kW Mono-bloc from 9 to 16kW All in One from 9 to 16kW (185L)	Bi-bloc from 9 to 12kW Mono-bloc from 9 to 12kW	From 80 to 295L

All data in this chart is applicable in most of models in each line up, check product specs to confirm. 1) H Generation T-CAP. 2) H Generation with C2-NS4P, F and G Generation with Heat Pump Manager.

# NEW AQUAREA H GENERATION A+++



The beauty of comfort. The new H Generation is being introduced from 3 to 16kW. The small capacities are specially designed for low energy homes and achieve an impressive COP of 5 (on the 3kW).

FREE  
MAINTENANCE  
STAINLESS TANK\*  
\* FOR ALL IN ONE H GENERATION

### Better Efficiency & Value A++/A++

- A++ for medium temperature applications (radiators. ErP 55°C)
- A++ for low temperature applications (floor heating. ErP 35°C)
- 3 & 5kW meet Sep'19 ErP regulation as A+++

### Aquarea, a new generation of energy efficient heating and hot water

Thanks to the system's high degree of technology and advanced control, it is able to maintain a high output capacity and efficiency even at -7°C and -15°C. The Aquarea's software can be set for the requirements of low consumption homes in order to maximise energy efficiency. Whatever the weather, Aquarea can work even at -20°C. The compact design of the outdoor unit makes installation very easy.

### New Design

New improved square design with white goods finish. Modern remote controller can be installed up to 50m from the indoor unit.

### Installer Friendly:

- Electrical connections is now located on front side
- Easy access to parts and easy to install by having all pipings in a row
- New remote controller with full dotted wide screen and new functions
- Can connect additional room temperature sensor, solar kit, 2 zones control, swimming pool and circulating pump (need optional PCB: CZ-NS4P)

### Compact and free space. More value in 1 compact space:

- Line strainer (easy access & fast clip technology)
- Isolation valves
- Electronic flow sensor
- 3 way valve ready (optional CZ-NV1 in internal space)

### New All in One with 2 zones control

- 2 heating circuits, with 2 different water temperatures
- 2 water pumps and 2 water filters
- Floor heating water control with mixing valve

2 Zones Kit included with control of 2 water temperatures  
(underfloor with water at 35°C and radiators with water at 45°C)

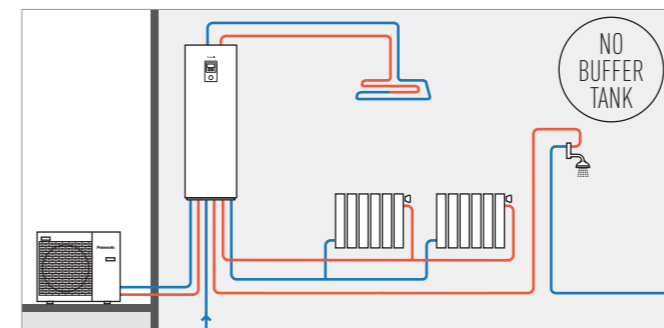

### New All in One, compact and easy to install

Space-saving solution ideal for installations with restricted space. In addition, Panasonic has developed bivalent and cascade systems that give the user control of two heating zones.

The Aquarea All in One belongs to the new generation of Panasonic heat pumps for heating, cooling and providing domestic hot water in the home. Aquarea T-CAP is one of the newest heat pumps on the market, maintaining nominal heating capacities even at temperatures as low as -20°C\*. This ensures the best possible seasonal energy efficiency ratio. The heat pumps are tested at an outdoor temperature of -28°C to ensure the most efficient and stable operation.

BEST IN TEST 2016: \* Applies to All in One T-CAP 5kW H Generation: The highest measured SCOP (energy efficiency) of all air/water heat pumps, in the corresponding category, that have been published on the heat pump list of the Danish Energy Agency: sparenergi.dk/forbrugerværktøjer/

### New Aquarea Smart Cloud for H Generation

**The most advanced heating control for today and for the future:** Easy and powerful energy management. The Aquarea Smart Cloud is much more than a simple thermostat for switching a heating device on or off. It is a powerful and intuitive service for remotely controlling the full range of heating and domestic hot water functions, including monitoring energy consumption, Malfunction notification, Failure Prediction & Remote Servicing as some options.

### Advanced Control

**Ease of use:** New remote controller with full dotted 3,5" wide back light screen provides clearer visibility to the user.

**Relocation:** Remote controller can be installed up to 50m from the indoor unit.

### New Accessory

Optional PCB (CZ-NS4P). With this new PCB you can also manage one or more functions like below: SG Ready, 0-10V demand signal, 2-zones control function (pump + mixing valve), solar and external switch (heat / cool).

# AQUAREA HIGH PERFORMANCE



For new installations and low consumption homes. Maximum savings, maximum efficiency, minimum CO<sub>2</sub> emissions, minimum of space.

### High Performance helps you to meet strict building requirements and reduce building costs

The heating and production of domestic hot water have a very important impact on the energy consumption of a house. Efficient Panasonic Heat Pumps can help to significantly reduce the energy consumption of the house.

#### Key points of the line-up



- Improved performance with COP's up to 5,08
- Reduced energy consumption through our "A" Class circulating pump
- Remote controller functions added: Auto mode, holiday mode, power consumption display

Panasonic has designed the new Aquarea Bi-bloc and Mono-bloc Heat Pumps for homes which have high performance requirements. Whatever the weather, Aquarea can work even at -20°C! The New Aquarea is easy to install on new or existing installations, in all types of properties.

### High Performance Pumps are also Highly Efficient (take the WH-MDC05F3E5 for example)

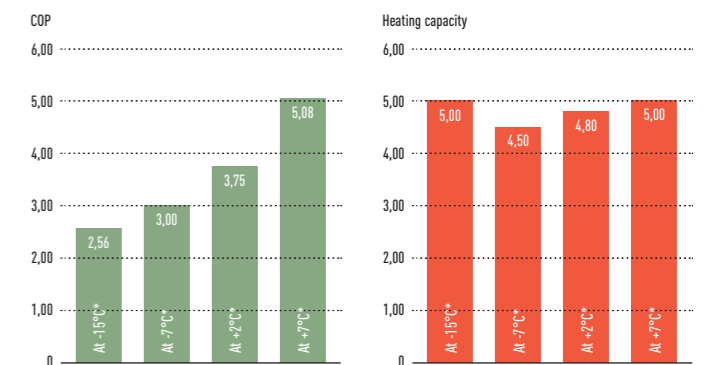

\* Heating water at 35°C.

### Standard circulating pumps vs "A" Class circulating pumps

Comparison of energy consumption of circulation pumps. New "A" Class circulating pump with Dynamic flow control for 5kW Mono-bloc.

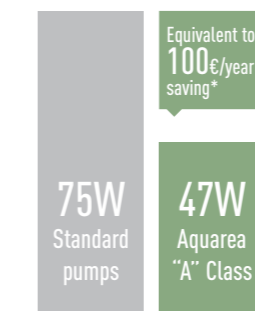

\* Based on German market: Assuming Standard pump may vary depending on consumption and energy cost.

### Panasonic created a night mode to reduce the noise when it's needed

Special attention has been given to noise levels

1. Sound pressure measured at 1m from the outdoor unit and at 1,5m height.
2. At standard condition working at heating capacity at +7°C (heating water at 35°C) for two fans outdoor units. For one fan outdoor units, night mode reduction is 3dB(A).

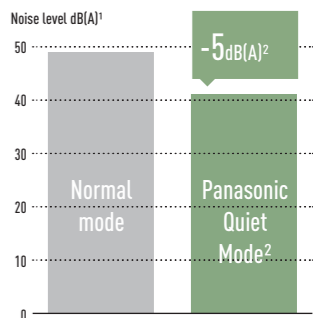

### Advanced Controller for H Generation



Improved visibility & Easy operation with large full dot LCD display and large touch panel!

Remote controller can be removed from indoor unit and installed in living room.

#### Key Points

Full large dot LCD screen (3,5 inch): High resolution screen with backlight, easy set up, check conditions easily, flat, innovative design, temperature sensor included in controller.

### Remote controller

Panasonic has introduced a new remote controller to improve performance, enhance comfort and deliver maximum savings.

#### New function for installer

- Floor heating concrete dry mode: Allows for a slow increase in temperature of underfloor heating via software.
- Heating and Cooling Mode: Authorised PRO Partners can enable the cooling mode through a special operation via the remote controller on site
- Circulating pump speed can be selected on the remote controller
- Pump speed is selected automatic based on demand

#### New function for End User

- Auto Mode: Automatically changes from heating to cooling depending on outdoor temperature.
- Energy Consumption Display: Displays the Heat Pump's energy consumption, split by heating, cooling and domestic hot water, showing the total consumption figure.
- Holiday Mode: Enables the system to resume at the preset temperature after your holiday

# AQUAREA T-CAP



For retrofit and new builds, install the T-CAP heat pump where the kW output capacity is demanding.

### Ensure the heating capacity is maintained even at low temperatures

The whole T-CAP line-up can replace old gas or oil boilers, and in a new application with underfloor heating, radiators or even fan-coil heaters, the whole T-CAP line-up is an ideal replacement for old gas/oil boilers. All Aquarea heat pumps can also be connected to a solar thermal or PV system in order to increase efficiency and minimise the impact on the ecosystem.

### Best efficiency compared to other heating systems

Panasonic Heat Pumps have a maximum COP of 4,85 at +7°C which makes them much more efficient than others heating systems.

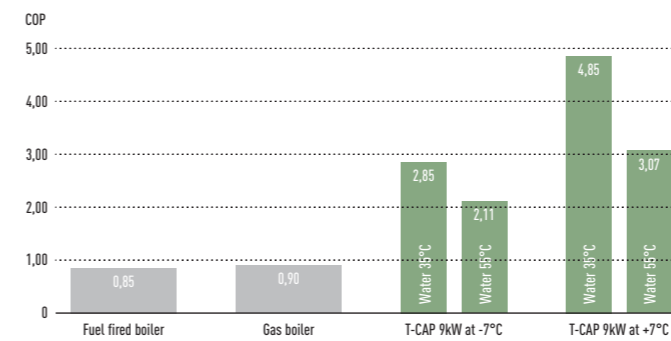

### More Energy saving

T-CAP is also able to provide extremely high efficiencies, whatever the outside or the water temperature.

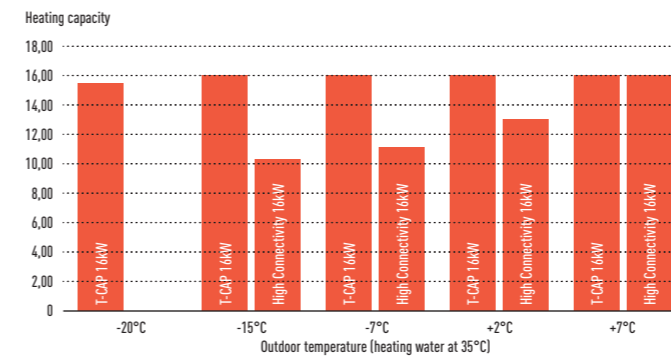

### Applications



For retrofit houses. Easy to replace expensive gas or oil boilers for high efficient 16kW T-CAP.



For commercial applications. Wide range of capacities from 9kW to 45kW. Also you are able to connect up to five Heat Pumps.



For heating and cooling mode. The 16kW is able to heat the water at 60°C and can work when the temperature is as low as -28°C.



For heating and domestic hot water. Efficient domestic hot water tanks allow large storage for high consumption of hot water.

### Key points of the line-up

- Ability to maintain the heat pump kW<sup>1</sup> output capacity until -20°C outdoor temperature without the help of an electrical booster heater
- High heating capacity even at low ambient temperatures
- Additional functions: Auto and holiday mode, boost, drying concrete and power consumption display
- Backup heater capacity can be selected depending on the model (3/6/9kW)
- Cooling mode activation possible via software<sup>2</sup>

<sup>1</sup>) At 35°C flow  
<sup>2</sup>) This activation can only be done by service partner or installer

### With a Panasonic heat pump, there is no need to oversize in order to reach the required capacity at low temperatures

- Panasonic's unique software and inverter technology for low consumption houses, allows the heat pump to produce heating water at 20°C. When only a little heating is required due to warmer outside air temperature
- All Aquarea heat pump's have a 10L expansion vessel fitted internally
- Aquarea heat pump's has an inverter compressor which can regulate the output capacity depending on demand
- New twin dice system included within the system (Twin fan outdoor unit)
- 3/6/9kW electrical heater is included in the heat pump (depending on unit)
- Panasonic heat pumps can work in outdoor temperatures as low as -28°C and guarantee the capacity without backup heating down to -15°C<sup>1</sup>
- Panasonic heat pumps are very quiet and have a noise reduction setting for night mode. See noise calculator on [www.panasonicproclub.com](http://www.panasonicproclub.com)

<sup>1</sup>) 35°C flow temperature.

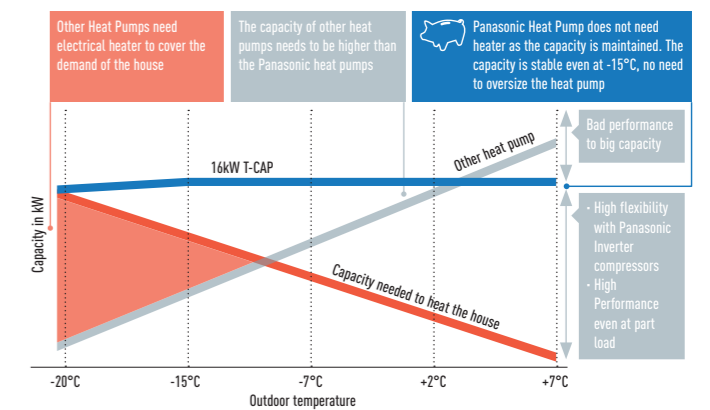

# AQUAREA HT



Aquarea HT can produce a flow temperature of 65°C making it the ideal high efficiency replacement for oil/gas boilers connected to high temperature radiators.

### Green energy source works with existing radiators

The Aquarea HT (9kW & 12kW) allows you to replace your traditional heating source (such as oil or gas) while keeping the existing old style radiators for minimum disruption to the home.

### Aquarea HT: High savings and low CO<sub>2</sub>

The benefit of replacing a traditional heating systems with Aquarea HT are clear: Reduced CO<sub>2</sub> emissions, future proofing running costs. Panasonic Heat Pumps are much more efficient than fossil fueled boilers and help you to reach your house energy targets.

### Yearly savings with Aquarea HT

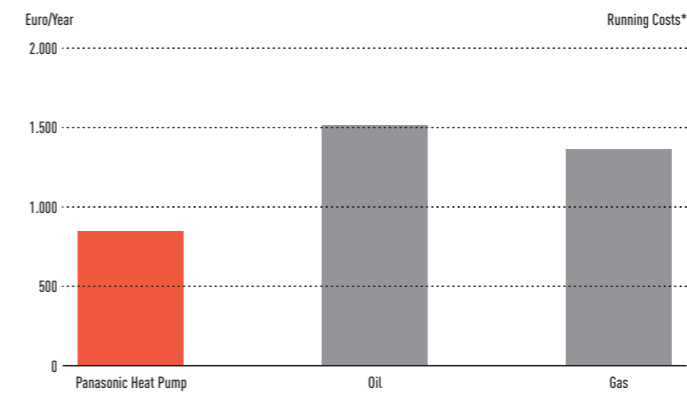

### Smart Bivalent operation

Using the Aquarea bivalent controller, it is now possible to combine different heat sources (boiler with heat pump) allowing to set up the system to operate in the most efficient way.



### Heat Pump + Boiler with DHW cylinder controlled by the smart bivalent controller

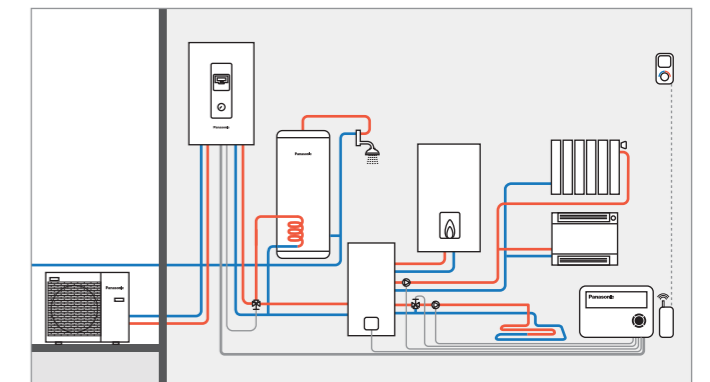

### Easy installation

Air source Heat Pumps are simple to install. They do not require a chimney, gas connection or oil/lpg tank. All that is required is a power supply connection.

### Panasonic Aquarea HT is highly efficient even at low outdoor temperatures

Heating Capacity of a 9kW HT (WH-SHF09F3E5).

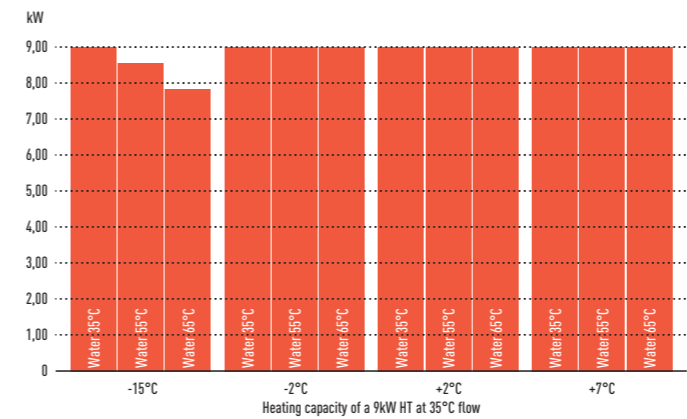

COP (Coefficient of Performance) of a 9kW HT (WH-MHF09G3E5).

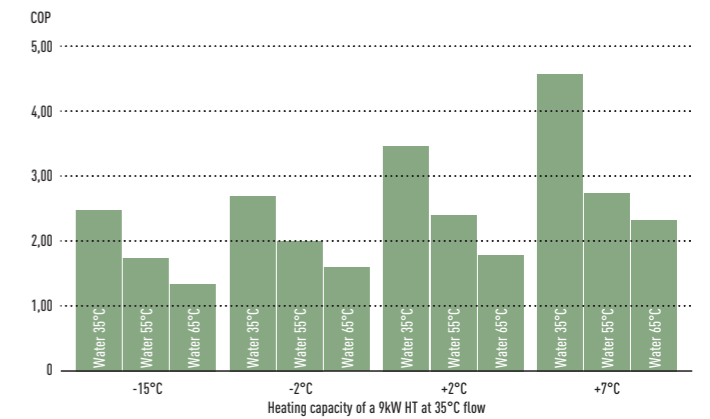

The Aquarea HT range is easy to install and is available with nominal heat outputs of 9kW or 12kW. These can be either single or three phase, in both Bi-bloc and Mono-bloc versions. The HT is also very quiet in operation with minimal noise inside the house due to no double stage compression cycle.



# AQUAREA COMMERCIAL

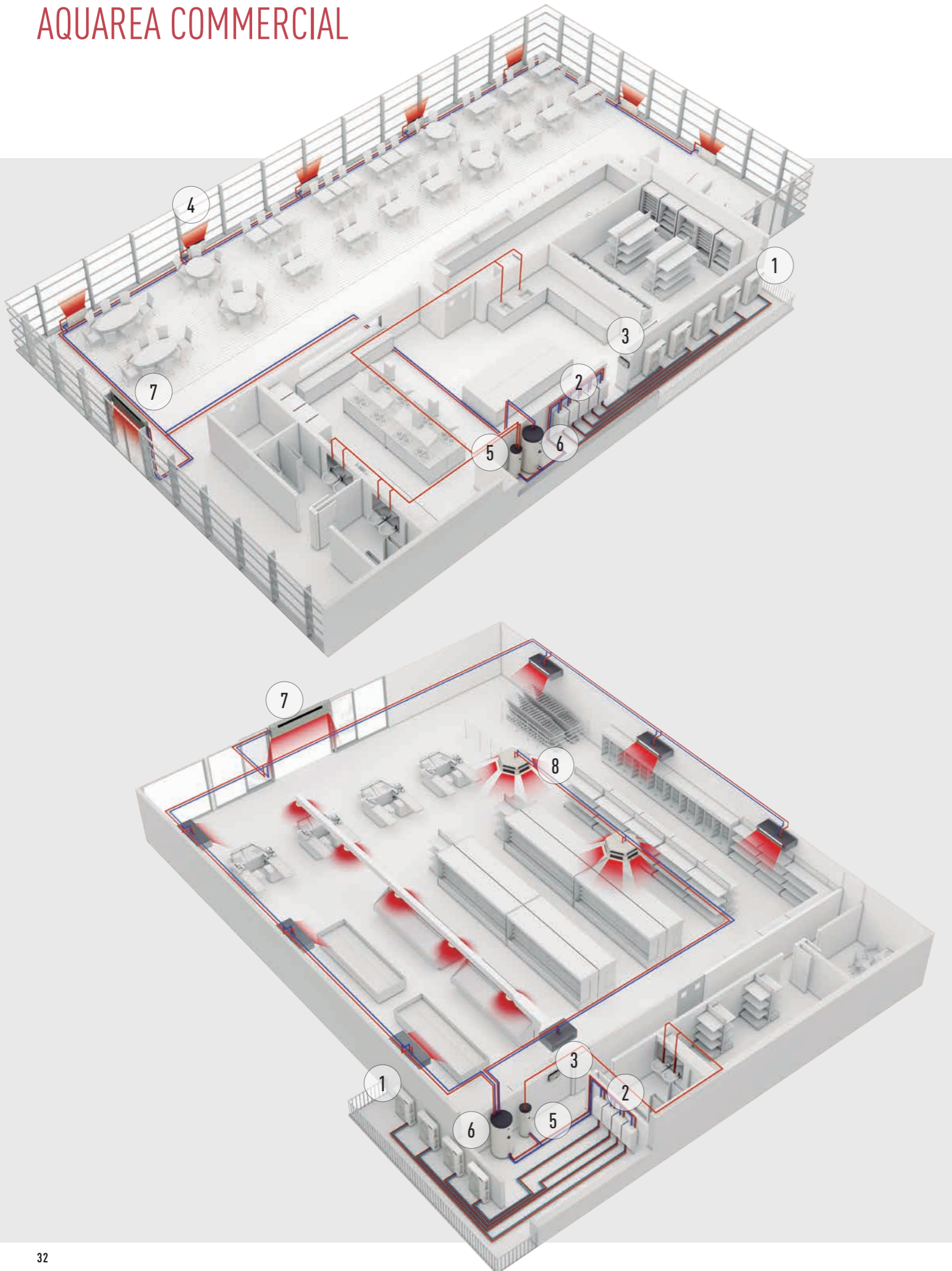

Solutions for best savings. Efficient Panasonic Heat Pumps can help to significantly reduce the energy consumption of your business. Recent improvements to air source Heat Pump technology, including compact single unit systems, can provide an ideal housing and commercial solution.

They offer space saving, energy-efficient heating and can be easily adapted for installation in flats, houses and commercial premises. Businesses producing heat, such as restaurants, installing an Aquarea Heat Pump system can also use this wasted heat to improve energy efficiency further.

### Restaurant with Aquarea

If you are looking for savings for your business, Aquarea is the right choice! Ideal for heating, cooling and for production of big quantities of hot water at 65°C, Aquarea have a extremely quick return on investment and a low CO<sub>2</sub> footprint.

#### Key points

- Produce hot water efficiency
- Fast return of investment
- Easy control
- Cascade management for higher durability of the system

\* 1 HPM can control 3 HP, on this case 2 HPM are needed

### Supermarket with Aquarea

Heat pump technology is scalable, meaning that it can be installed in buildings of varying sizes, offering both small- and large-scale heating solutions. The technology is also environmentally friendly when compared to existing technologies, offering demonstrable energy-use and emissions savings and in most cases; will deliver operational cost savings when compared with fossil fuel alternatives.

### Can be integrated in the water system

Easy connection to existing system

- Fan Coils
- Floor Heating
- 4 way and 2 way convectors
- Domestic hot water tanks
- High efficiency
- Very good part load management
- Cascade management for higher durability of the system

\* 1 HPM can control 3 HP, on this case 2 HPM are needed



**1**  
Aquarea T-CAP  
Heat Pump 16kW on cascade mode.



**2**  
High Efficiency Aquarea Hydrokit



**3**  
HPM to control the Heat Pumps on cascade mode\*



**4**  
High efficiency Aquarea Air radiators  
32% more efficient than standard radiators.



**5**  
Super high efficiency Tanks  
From 200L to 500L for domestic hot water.

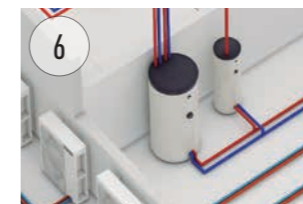

**6**  
Buffer Tank of 1.000L



**7**  
Air Curtain with DX Coil  
Designed for smooth operation and efficient performance.



**8**  
Convectors

### Case study: Carluccio's restaurant

On of UK's leading Italian restaurant, Carluccio's, wanted to install a system which would provide the desired volume of hot water, at the correct temperature while at the same time reduced energy costs. Previous restaurants in the chain had been fitted with a more traditional 12kW boiler system. FWP installed a 12kW Aquarea T-CAP mono bloc unit which would allow for the free air from the kitchen roof space to be transferred through

condensing unit providing hot water at the optimum temperature. With a high coefficient of performance (COP), the system returns an impressive 4kW of energy, for every kW used. This makes the Aquarea far more cost effective than a conventional heating system. To heat the water for their Leeds restaurant cost £3782 whilst at the Meadowhall site the comparable cost was just £951. These sizeable savings mean the site will see a return on investment in approximately 2 years.

# NEW AQUAREA SMART CLOUD FOR H GENERATION

## The most advanced heating control for today and for the future

### Easy and powerful energy management

The Aquarea Smart Cloud is much more than a simple thermostat for switching a heating device on or off. It is a powerful and intuitive service for remotely controlling the full range of heating and hot water functions, including monitoring energy consumption.

New functions for maintenance companies will be added during 1st Half of 2018 making advanced remote maintenance available to users and companies using any device.

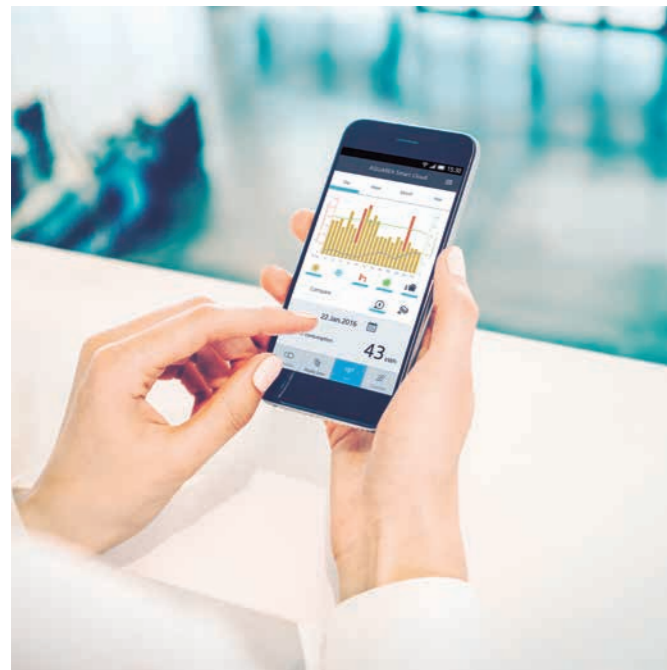

### Advantages

Energy savings, comfort and control from anywhere. Increase efficiency and resources management, operating costs savings and owner satisfaction. Throughout 2018 Panasonic will add new services to the Aquarea Smart Cloud focused on enabling full remote maintenance of the Aquarea system. This will allow maintenance specialists to engage in predictive maintenance and system fine-tuning, as well as fixing malfunctions when they occur.

Aquarea compatibility	H Generation
Connection point	CN-CNT Aquarea port
Home router connection	Wireless or Wired LAN
Temperature sensor	Can use remote controller sensor
Tablet or PC browser compatibility*	Yes
Operation from remote — On/Off — House Temp setting mode selection — DHW setting — Error codes — Scheduling	Yes
Heating areas	Up to 2 zones
Power consumption estimation — Operation log history	Yes — Yes

\* Check browsers and version compatibility.

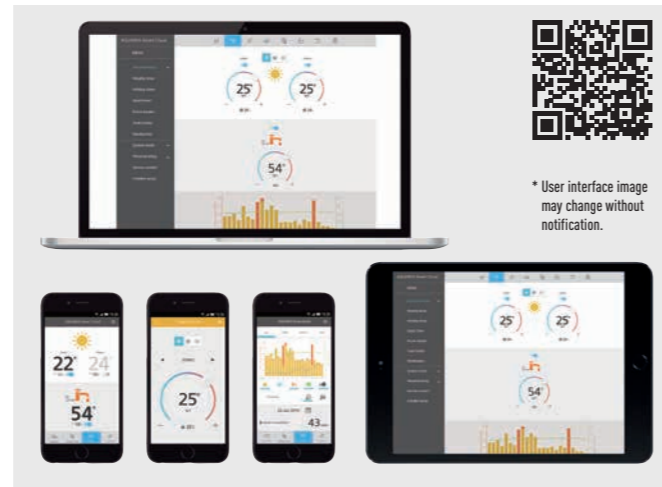

\* User interface image may change without notification.

### How it works?

Connect Aquarea H Generation system to the cloud using wireless LAN or a wired LAN Network. User connects to the Cloud portal to remotely operate all unit functions and can also permit partners to access customised functions for remote maintenance and monitoring. See demo: <https://aquarea.aircon.panasonic.eu>

### Requirements

1. H Generation Aquarea system
2. In-house internet connection with router wireless LAN or wired LAN
3. Get a Panasonic ID in <https://aquarea-smart.panasonic.com/>

### 2 step introduction with same hardware: CZ-TAW1

	Step 1	Step 2 (during 2018) Same CZ-TAW1 hardware. Changes implemented in the cloud server.
--	--------	---

#### End User management and energy control

Visualization & Control	✓	—
Scheduling	✓	—
Energy Statistics	✓	—
Malfunction notification	✓	—

#### Advanced functions for remote maintenance with professional screens<sup>1</sup>

Monitoring	—	✓
Control	—	✓
Statistics (exportable)	—	✓
Remote Service	—	✓

1) Advanced functions not confirmed, final ones might differ from this list.



1. LAN  
2. Aquarea connection by CN-CNT

# CONTROL & CONNECTIVITY

Home connectivity and Home Managements Systems integration is becoming more and more popular. These integrations helps to control all house devices from centralised platform and helps to optimise the operation and running costs. Panasonic interfaces are made to work with

both Modbus and KNX, the most populars protocols. Also for non integrated control, Panasonic developed a simple connection to Wireless LAN, with this End User can control remotely its own heat pump from wherever.

### Internet Control

#### What's Internet Control?

Aquarea heat pumps can be connected to Internet thru wireless LAN. When connection is done unit can be controlled from wherever and whenever with just Computer or Smartphone. Offering full system operation and error code messages, CZ-TAW1 offers full scheduling and powerful consumption stats. This device is ready for future improvements in the server, bringing advanced new functions for remote maintenance. This advanced features will bring quicker service to user and time savings to installers and maintenance companies.



### Connectivity. Control by BMS

Great flexibility for integration into your KNX / Modbus projects allows fully bi-directional monitoring and control of all the functioning parameters.

#### Interface to connect Aquarea to KNX

Reference: PAW-AW-KNX-1i / PAW-AW-KNX-H



These new interfaces allows full monitoring and control, bi-directional, of all the functioning parameters of Aquarea control from KNX installations.

- Small dimensions. / Quick installation and possibility of hidden installation
- External power not required
- Direct connection to the unit
- Fully KNX interoperable: Control and monitoring, from sensors or gateways, of the internal variables of the indoor unit and error codes and indication
- Aquarea unit can be controlled simultaneously by its remote controller and by KNX Master devices



#### Interface to connect Aquarea to Modbus

Reference: PAW-AW-MBS-1 / PAW-AW-MBS-H



These new interfaces allows full monitoring and control, bi-directional, of all the functioning parameters of Aquarea control from Modbus installations.

- Small dimensions. / Quick installation and possibility of hidden installation
- External power not required
- Direct connection to the unit
- Fully Modbus interoperable: Control and monitoring, from any BMS or PLC Modbus Master, of internal variables of the indoor unit and error codes and indication
- Aquarea unit can be controlled simultaneously by its remote controller and by Modbus Master devices

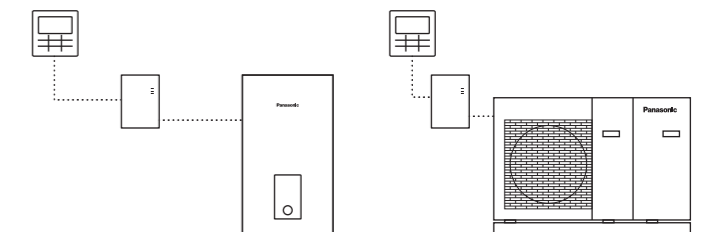

Model name	Interface
PAW-AW-KNX-H	KNX interface for H Generation
PAW-AW-MBS-H	Modbus interface for H Generation
PAW-AW-KNX-1i	KNX interface (not compatible with H Generation)
PAW-AW-MBS-1	Modbus interface (not compatible with H Generation)
PA-AW-WIFI-TE1	Internet control Wifi connection (not compatible with H Generation)
CZ-TAW1	Aquarea Smart Cloud, H Generation Internet control through Wifi or wired LAN

# REMOTE CONTROLLER



## Advanced controller for H Generation

Improved visibility & easy operation by full dotted LCD panel and large touch panel!

Remote controller can be removed from indoor unit and installed in living room.

### Key Points

- Full dot big LCD screen (3,5 inch)
- High resolution screen with backlight
- Easy set up
- Check conditions easily even at the living room
- Flat, innovative design
- Temperature Sensor included in controller

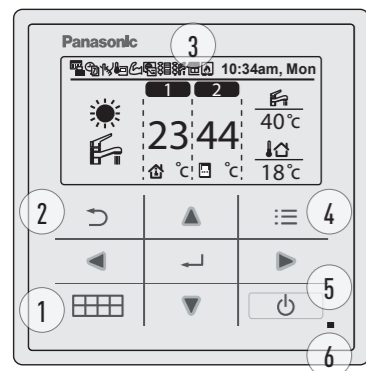

1. Quick Menu button (For more details, refer to the separate Quick Menu Guide)
2. Back button. Returns to the previous screen
3. LCD Display
4. Main Menu button. For function setup
5. ON/OFF button. Starts/Stops operation
6. Operation indicator. Illuminates during operation, blinks during alarm



## Remote controller for F and G Generation

Panasonic has introduced a new remote controller to improve performance, enhance comfort and deliver maximum savings.

### New function for installer

- Floor heating concrete dry mode: Allows slow increase in temperature of floor heating via software
- Heating and Cooling Mode: Authorized service partner or Authorized installer can enable the cooling mode through a special operation via the remote controller on site
- Pump with 7 speeds: Pump speed can be selected on the remote controller

### New function for end user

- Auto Mode: Automatically changes from heating to cooling depending on outdoor temperature.
- Energy Consumption: Displays the heat pump's energy consumption, split by heating, cooling and domestic hot water, and shows total consumption figure
- Holiday Mode: Enables the system to resume at the preset temperature after your holiday

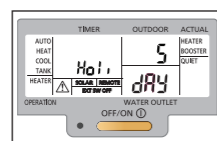
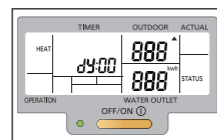

### New Remote controller changing point Better user interface:

1. Adding Holiday Mode
2. Adding Power Consumption

### LCD display:

1. Expand LCD display to show mode on left and right side
2. Adding AUTO mode and remove defrost display (using heat blink)
3. Change not available into EXT SW OFF
4. Adding kWh and Hr

### Button:

5. Adding holiday button
6. Change force and error reset position

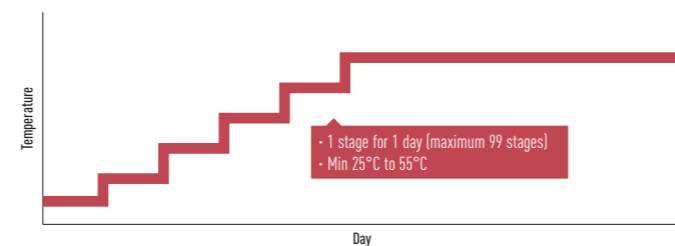
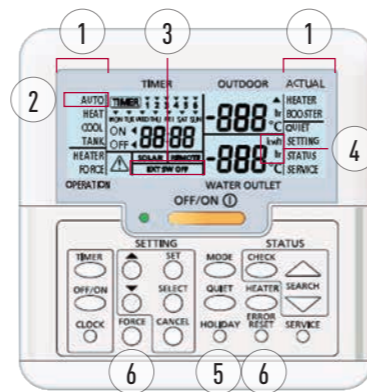

# HEAT PUMP MANAGER



Connected to a router, all information of the heating system controlled by the HPM is available via the internet. Installers, service companies and end-users can monitor the installation remotely. Panasonic has developed a new easy start up mode for the HPM. Start your bivalent system in just 10 minutes!

### Easy Installation & Easy Configuration

Ready: Pre-programmed with up to 610 applications/system diagrams  
Steady: At start up - state the number of application/system diagram  
Go: The controller starts working according to selected diagram

### The next generation of Aquarea Manager

This new generation of smart controllers for eco-efficient heating features our versatile stand-alone controller for heating and domestic hot water.

### Panasonic offers:

Trends. Statistics. Consumption Energy Management-Optimization. Alarm. Handling + Maintenance. Complete documentation etc.



### Key points

- Easy selection with the "ready to go" system
- Up to 610 preconfiguration installations available on [www.panasonicproclub.com](http://www.panasonicproclub.com)
- Cascade system possible for big installations
- Bivalent control in order to also manage gas boilers
- Able to control 2 mixed heated zones
- Smart grid ready
- Solar panel mode in order to produce heat when the PV is generating electricity
- Online access with control of all parameters
- Easy installation, needing less than 3 minutes to configure a complex system

### Technical Specification

- New function: Smart Setup
- Control of 2 x Mixed Heating Circuits
- Floor screed dry program
- Cascade/bivalent controller
- Automatic switch from heating to cooling mode
- Night shift: - Internal Energy Manager
- Solar collector control
- Domestic hot water priority
- Easy to startup – easy to operate
- 7 output relays
- 0-10 V In/Output Signal
- 8 Sensor inputs (PT1000)
- USB interface (upload, service, remote controller, trend)
- RS485 interface (com. with additional heat pump)
- RS485 interface (for external display)
- Built-in backlit text display

### Easy mounting

Simple mounting without screws in the cabinet/door or on DIN-rail. Also possible to mount directly on to the wall.



# AQUAREA + PV PANELS

## Key points

- Increases the amount of self-consumed electricity from the solar system up to 120%
- Control the heat pump's energy consumption according to the output of electricity from the PV considering the electric energy consumption requirement of the house

- Innovative algorithm balancing the heat pump's consumption and the in-house comfort, based on the outside temperature and the energy demand of the building
- Easy configuration of the Heat Pump manager system with the PV system

## For F and G Generation

Panasonic has developed an innovative algorithm for its HPM (Heat Pump Manager) which drastically improves the Heat Pump's use of self-generated electricity from connected Photovoltaic panels. The Heat Pump will take the electricity generation by the solar system into consideration for the heating system and the domestic hot water production, without reducing comfort in the house.

## For H Generation

Aquarea H Generation can synchronize with PV panel with simple CZ-NS4P PCB. A part of converting Aquarea in Smart Grid Ready, there is a new advantage, this new PCB allows 0-10V control. With this Aquarea demand is adapting all moment with the PV Panel production.

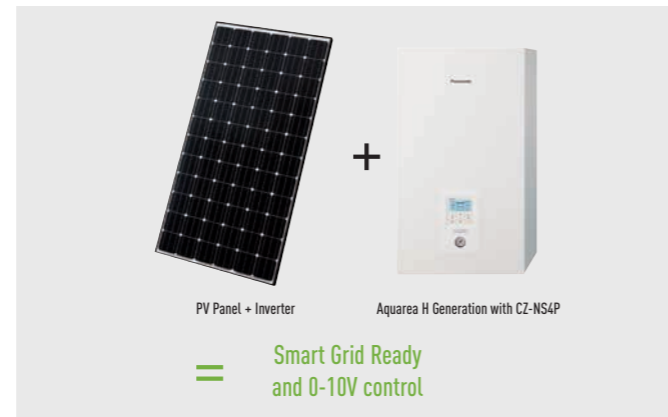
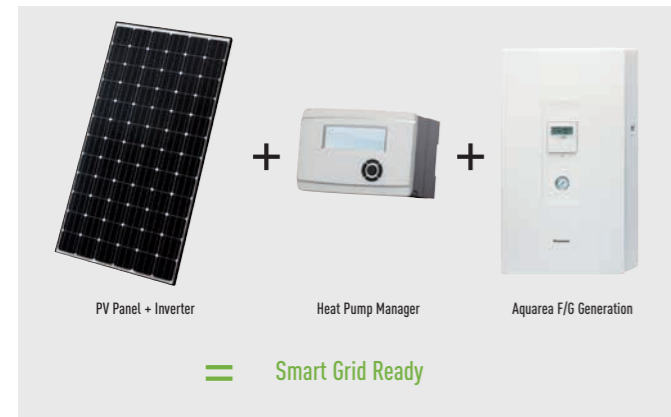

Produce and heat Domestic Hot Water for free.

## Comparison on new housing.

Increase usage of self production by: 120%

The Panasonic Aquarea PV Control could increase the energy consumption of the heat pump coming from the Photovoltaic Panels from 352kWh to 775kWh a year. Results of simulations:

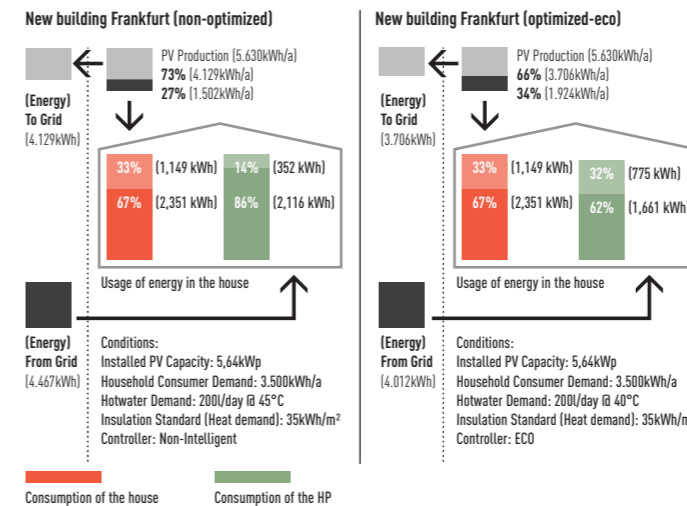

## Comparison on old housing.

Increase usage of self production by: 71%

The Panasonic Aquarea PV Control could increase the energy consumption of the heat pump coming from the Photovoltaic Panels from 526kWh to 898kWh a year. Results of simulations:

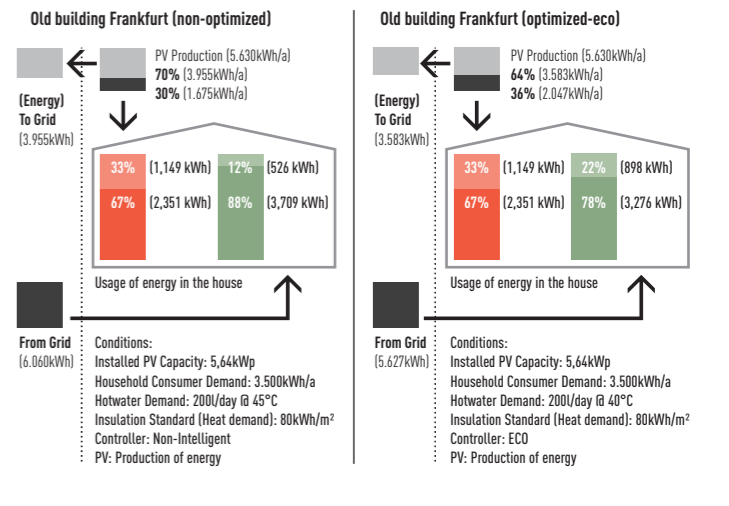

## PV + HP control

How to create added value of the combination PV+HP?



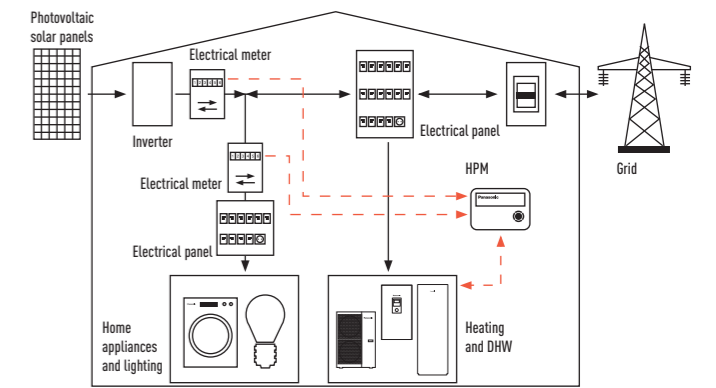



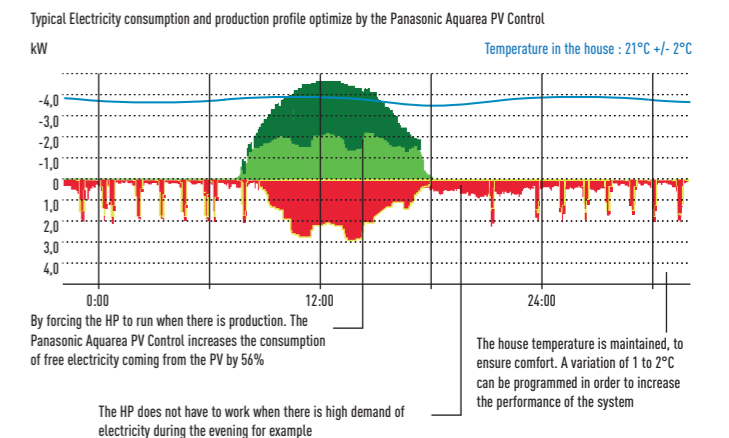
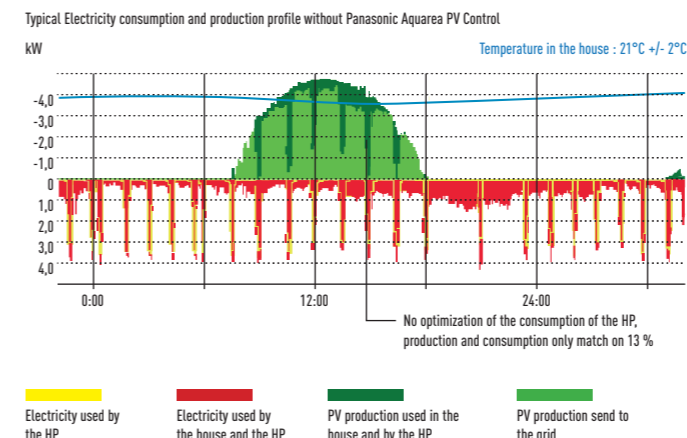

































- Optimize the HP considering the PV production
- When the PV is producing enough to cover the HP consumption, then Tank mode will be forced to heat up the DHW to 55 or 65 degrees
- If buffer tank on the installation, temperature on the buffer tank will increase 1-to 5 degrees or up to 55°C.



## Standard combination PV+HP. Why the Panasonic Aquarea PV Control can increase by 120% the performance of the combination PV+HP



# AQUAREA HEAT PUMPS LINE-UP

			3kW	5kW	7kW	9kW	12kW	16kW
<b>Aquarea High Performance</b> for well insulated houses 	<b>All in One</b> Single Phase Three Phase Heating, cooling and DHW 	 WH-ADC0309H3E5 WH-ADC0309H3E5B WH-UD03HE5(-1)	 WH-ADC0309H3E5 WH-ADC0309H3E5B WH-UD05HE5(-1)	 WH-ADC0309H3E5 WH-ADC0309H3E5B WH-UD07HE5(-1)	 WH-ADC0309H3E5 WH-ADC0309H3E5B WH-UD09HE5(-1) WH-ADC0916H9E8 WH-UD09HE8	 WH-ADC1216H6E5 WH-UD12HE5 WH-ADC1216G6E5 <sup>1</sup> WH-UD12FE5 WH-ADC0916H9E8 WH-UD12HE8	 WH-ADC1216H6E5 WH-UD16HE5 WH-ADC1216G6E5 <sup>1</sup> WH-UD16FE5 WH-ADC0916H9E8 WH-UD16HE8	
	<b>Bi-bloc</b> Single Phase Three Phase Heating and cooling 	 WH-SDC03H3E5(-1) WH-UD03HE5(-1)	 WH-SDC05H3E5(-1) WH-UD05HE5(-1)	 WH-SDC07H3E5(-1) WH-UD07HE5(-1)	 WH-SDC09H3E5(-1) WH-UD09HE5(-1) WH-SDC09H3E8 WH-UD09HE8	 WH-SDC12H6E5 WH-UD12HE5 WH-SDC12H9E8 WH-UD12HE8 WH-SDC12F6E5 <sup>2</sup> WH-UD12FE5	 WH-SDC16H6E5 WH-UD16HE5 WH-SDC16H9E8 WH-UD16HE8 WH-SDC16F6E5 <sup>2</sup> WH-UD16FE5	
	<b>Mono-bloc</b> Single Phase Heating and cooling 		 WH-MDC05H3E5 WH-MDC05F3E5	 WH-MDC07H3E5 WH-MDC06G3E5 (6kW)	 WH-MDC09H3E5 WH-MDC09G3E5	 WH-MDC12G6E5	 WH-MDC16G6E5	
<b>Aquarea T-CAP High Capacity</b> for cold areas 	<b>All in One</b> Single Phase Three Phase Heating, cooling and DHW 				 WH-ADC1216H6E5 WH-UX09HE5 WH-ADC0916H9E8 WH-UX09HE8	 WH-ADC1216H6E5 WH-UX12HE5 WH-ADC0916H9E8 WH-UX12HE8	 WH-ADC0916H9E8 WH-UX16HE8	
	<b>Bi-bloc</b> Single Phase Three Phase Heating and cooling 				 WH-SXC09H3E5 WH-UX09HE5 WH-SXC09H3E8 WH-UX09HE8 WH-SDC09H3E8 WH-UD09HE8	 WH-SXC12H6E5 WH-UX12HE5 WH-SXC12H9E8 WH-UX12HE8 WH-SDC12H9E8 WH-UD12HE8	 WH-SXC16H9E8 WH-UX16HE8 WH-SDC16H9E8 WH-UD16HE8	
	<b>Mono-bloc</b> Single Phase Three Phase Heating and cooling 				 WH-MXC09G3E5 WH-MXC09G3E8	 WH-MXC12G6E5 WH-MXC12G9E8	 WH-MXC16G9E8	
<b>Aquarea HT for retrofit</b> 	<b>Bi-bloc</b> Single Phase Three Phase Heating only 				 WH-SHF09F3E5 WH-UH09FE5 WH-SHF09F3E8 WH-UH09FE8	 WH-SHF12F6E5 WH-UH12FE5 WH-SHF12F9E8 WH-UH12FE8		
	<b>Mono-bloc</b> Single Phase Heating only 				 WH-MHF09G3E5	 WH-MHF12G6E5		

WH-\_\_E5 Single Phase // WH-\_\_E8 Three Phase. 1) All in One G Generation model. 2) Hydrokit F Generation model.

# AQUAREA ALL IN ONE H GENERATION HIGH PERFORMANCE BI-BLOC SINGLE PHASE / THREE PHASE. HEATING AND COOLING. 1 ZONE HYDROKIT OR 2 ZONES BUILT-IN HYDROKIT

Panasonic has developed a highly efficient solution, easy to install.

Aquarea All in One is the new generation of Panasonic Heat Pumps for Heating, Cooling and Domestic Hot Water (DHW). This new range intelligently integrates the best Hydrokit technology with a premium quality stainless steel tank, which also comes with a 10 year warranty.

### Technical focus

- **NEW!** Indoor Unit
- **NEW!** Touch Controller

- Space saving: 1.800 x 598 x 717 (H x W x D)
- Reduced installation costs
- Piping at the bottom of the All in One (easy to install)
- Reduced installation time and minimised installation errors
- Easy remote controller to set up
- Reduced installation spaces
- Electrical connections at the front
- Easier installation and maintenance
- New remote controller functions (cooling mode activation possible by software. This activation can only be done by service partner)



NEW TECHNOLOGY 17

FREE MAINTENANCE STAINLESS TANK

# AQUAREA ALL IN ONE H GENERATION T-CAP BI-BLOC SINGLE PHASE / THREE PHASE. HEATING AND COOLING

### Benefits of the T-CAP All in One unit!

Aquarea T-CAP can work in extreme outdoor conditions as low as -28°C and warranty the capacity without back up heating down to -20°C. Ready to work at extreme outdoor conditions the H Generation T-CAP can produce water up to 60°C, expanding its possibilities for retrofit application. On top of All in One Aquarea unique advantages, the quickest installation in the market and easy maintenance including the outstanding inox tank maintenance free.

### Technical focus

- **NEW!** Indoor Unit
- **NEW!** Touch Controller

- Works at temperatures as low as -28°C
- Constant capacity up to -20°C
- Space saving: 1.800 x 598 x 717 (H x W x D)
- Reduced installation costs
- Piping at the bottom of the All in One (easy to install)
- Reduced installation time and minimised installation errors
- Easy remote controller to set up
- Reduced installation spaces
- Electrical connections at the front
- Easier installation and maintenance
- 1 phase and 3 phase
- New remote controller functions (cooling mode activation possible by software. This activation can only be done by service partner)



NEW TECHNOLOGY 17

FREE MAINTENANCE STAINLESS TANK

Kit	Single Phase (Power to indoor)					Three Phase (Power to indoor)					
	KIT-ADC03HE5	KIT-ADC05HE5	KIT-ADC07HE5	KIT-ADC09HE5	KIT-ADC12HE51*	KIT-ADC16HE51*	KIT-ADC09HE8²	KIT-ADC12HE8²	KIT-ADC16HE8²		
Heating capacity at +7°C (heating water at 35°C)	3,20		5,00		7,00		9,00		12,00		
COP at +7°C (heating water at 35°C)	5,00		4,63		4,46		4,13		4,74		
Heating capacity at +2°C (heating water at 35°C)	3,20		4,20		6,55		6,70		11,40		
COP at +2°C (heating water at 35°C)	3,56		3,11		3,34		3,13		3,44		
Heating capacity at -7°C (heating water at 35°C)	3,20		4,20		5,15		5,90		10,00		
COP at -7°C (heating water at 35°C)	2,69		2,59		2,68		2,52		2,73		
Cooling capacity at 35°C (cooling water at 7/12°C)	3,20		4,50		6,00		7,00		10,00		
EER at 35°C (cooling water at 7/12°C)	3,08		2,69		2,63		2,43		2,56		
Energy Efficiency Class at 35°C / at 55°C / at 55°C for DHW	A++ / A++ / A		A++ / A++ / A		A++ / A++ / A		A++ / A++ / A		A++ / A++ / A		
System label 35°C / 55°C³	A+++ / A++		A+++ / A++		A+++ / A++		A+++ / A++		A+++ / A++		
Indoor unit 1 zone	WH-ADC0309H3E5		WH-ADC0309H3E5		WH-ADC0309H3E5		WH-ADC0309H3E5		WH-ADC0916H9E8		
Indoor unit 2 zones	WH-ADC0309H3E5B		WH-ADC0309H3E5B		WH-ADC0309H3E5B		WH-ADC0916H9E8		WH-ADC0916H9E8		
Sound pressure	Heating / Cooling	dB(A)		28 / 28		28 / 28		33 / 33		33 / 33	
Dimensions* / Net Weight*	H x W x D	mm / kg		1.800 x 598 x 717 / 124		1.800 x 598 x 717 / 124		1.800 x 598 x 717 / 126		1.800 x 598 x 717 / 126	
Water pipe connector		mm		R 1 1/4		R 1 1/4		R 1 1/4		R 1 1/4	
A class Pump	Number of speeds	Variable Speed		Variable Speed		Variable Speed		Variable Speed		Variable Speed	
	Input power (Min / Max)*	W		30 / 120		30 / 120		36 / 152		36 / 152	
Heating water flow (ΔT=5 K, 35°C)		l/min		9,2		14,3		20,1		25,8	
Capacity of integrated electric heater		kW		3		3		6		9	
Recommended Fuse		A		15 / 15		15 / 15		30 / 15		30 / 15	
Recommended cable size, supply 1 & 2		mm²		3 x 1,5 / 3 x 1,5		3 x 1,5 / 3 x 1,5		3 x 2,5 / 3 x 1,5		3 x 4,0 / 3 x 4,0	
Water volume		L		185		185		185		185	
Maximum water temperature		°C		65		65		65		65	
Material inside tank		Stainless steel		Stainless steel		Stainless steel		Stainless steel		Stainless steel	
Outdoor Unit		WH-UD03HE5-1		WH-UD05HE5-1		WH-UD07HE5-1		WH-UD09HE5-1		WH-UD12HE5	
Sound pressure	Heating / Cooling	dB(A)		48 / 47		49 / 48		50 / 48		51 / 50	
Sound power level	Heating / Cooling	dB		64 / 65		65 / 66		68 / 66		67 / 68	
Dimensions / Weight	H x W x D	mm / kg		622 x 824 x 298 / 39		622 x 824 x 298 / 39		795 x 900 x 320 / 66		795 x 900 x 320 / 66	
Refrigerant (R410A)		kg		1,20		1,20		1,45		1,45	
Pipe diameter	Liquid / Gas	Inch (mm)		1/4 (6,35) / 1/2 (12,7)		1/4 (6,35) / 1/2 (12,7)		3/8 (9,52) / 5/8 (15,88)		3/8 (9,52) / 5/8 (15,88)	
Pipe length range / Elevation difference (in/out)		m		3 - 15 / 5		3 - 15 / 5		3 - 30 / 20		3 - 30 / 20	
Pipe length for additional gas / Additional gas amount		m / g/m		10 / 20		10 / 20		10 / 30		10 / 30	
Operation range	Outdoor ambient	°C		-20 ~ +35		-20 ~ +35		-20 ~ +35		-20 ~ +35	
Water outlet	Heating / Cooling	°C		25 - 55 / 5 - 20		25 - 55 / 5 - 20		25 - 55 / 5 - 20		25 - 55 / 5 - 20	

Accessories	
PAW-ADC-PREKIT-1	Pre installation kit for piping
PAW-ADC-CV150	Decorative magnetic side cover
CZ-NS4P	Additional functions PCB

Accessories	
CZ-TAW1	Aquarea Smart Cloud, H Generation Internet control through Wifi or wired LAN
PAW-A2W-RTWIRED	Room thermostat

COP classification is at 230V only in accordance with EU directive 2002/32/EC. Sound pressure measured at 1m from the outdoor unit and at 1,5m height. Heating sound pressure measured at +7°C (heating water at 55°C). Performance in agreement with EN14511. Insulated tested under EN12897. 1) Available in August 2017. 2) Available in March 2017. 3) System label with controller. \* Tentative data.



Kit	Single Phase (Power to indoor)		Three Phase (Power to indoor)		
	KIT-AXC9HE5¹	KIT-AXC12HE5¹	KIT-AXC9HE8²	KIT-AXC12HE8²	
Heating capacity at +7°C (heating water at 35°C)	9,00		12,00		
COP at +7°C (heating water at 35°C)	4,84		4,74		
Heating capacity at +2°C (heating water at 35°C)	9,00		12,00		
COP at +2°C (heating water at 35°C)	3,59		3,44		
Heating capacity at -7°C (heating water at 35°C)	9,00		12,00		
COP at -7°C (heating water at 35°C)	2,85		2,72		
Cooling capacity at 35°C (cooling water at 7/12°C)	7,00		10,00		
EER at 35°C (cooling water at 7/12°C)	3,17		2,81		
Energy Efficiency Class at 35°C / at 55°C / at 55°C for DHW	A++ / A++ / A		A++ / A++ / A		
System label 35°C / 55°C³	A+++ / A++		A+++ / A++		
Indoor unit	WH-ADC1216H6E5		WH-ADC1216H6E5		
Sound pressure	Heating / Cooling	dB(A)		33 / 33	
Dimensions* / Net Weight*	H x W x D	mm / kg		1.800 x 598 x 717 / 137	
Water pipe connector		mm		R 1 1/4	
A class pump	Number of speeds	Variable Speed		Variable Speed	
	Input power (Min / Max)*	W		36 / 152	
Heating water flow (ΔT=5 K, 35°C)		l/min		25,8	
Capacity of integrated electric heater		kW		6	
Recommended fuse		A		30 / 30	
Recommended cable size, supply 1 & 2		mm²		3 x 4,0 / 3 x 4,0	
Water volume		L		185	
Maximum water temperature		°C		65	
Material inside tank		Stainless steel		Stainless steel	
Outdoor Unit		WH-UX09HE5		WH-UX12HE5	
Sound pressure	Heating / Cooling	dB(A)		51 / 49	
Sound power level	Heating / Cooling	dB		68 / 67	
Dimensions / Weight	H x W x D	mm / kg		1.340 x 900 x 320 / 101	
Refrigerant (R410A)		kg		2,85	
Pipe diameter	Liquid / Gas	Inch (mm)		3/8 (9,52) / 5/8 (15,88)	
Pipe length range / Elevation difference (in/out)		m		3 - 30 / 20	
Pipe length for additional gas / Additional gas amount		m / g/m		10 / 50	
Operation range	Outdoor ambient	°C		-28 ~ +35	
Water outlet	Heating / Cooling	°C		25 - 60 / 5 - 20	

Accessories	
PAW-ADC-PREKIT-1	Pre installation kit for piping
PAW-ADC-CV150	Decorative magnetic side cover
CZ-NS4P	Additional functions PCB

Accessories	
CZ-TAW1	Aquarea Smart Cloud, H Generation Internet control through Wifi or wired LAN
PAW-A2W-RTWIRED	Room thermostat

COP classification is at 230V only in accordance with EU directive 2002/32/EC. Sound pressure measured at 1m from the outdoor unit and at 1,5m height. Heating sound pressure measured at +7°C (heating water at 55°C). Performance in agreement with EN14511. Insulated tested under EN12897. 1) Available in July 2017. 2) Available in March 2017. 3) System label with controller. \* Tentative data.



# AQUAREA ALL IN ONE HIGH PERFORMANCE BI-BLOC SINGLE PHASE / THREE PHASE. HEATING AND COOLING

Panasonic has developed a highly efficient solution, easy to install.

Panasonic combines the finest product design with performance to achieve a market-leading COP.

### Technical focus

- Space saving: 1.800 x 598 x 717 (H x W x D)
- Reduced installation costs
- Piping at the bottom of the All in One (easy to install)
- Reduced installation time and minimised

- installation errors
- Easy remote controller to set up
- Electrical connections at the front
- Reduced installation spaces
- All piping connections at bottom of the indoor unit
- Easier installation and maintenance
- New remote controller functions (cooling mode activation possible by software. This activation can only be done by service partner)



WH-UD12FE5  
WH-UD16FE5  
WH-UD09FE8



# AQUAREA ALL IN ONE T-CAP BI-BLOC SINGLE PHASE. HEATING AND COOLING

All the benefits of the T-CAP All in One unit!

Panasonic has developed a highly efficient solution, easy to install. Ideal for installation in new homes, Aquarea All in One is also particularly suited for retrofit projects, saving installation time and space.

### Technical focus

- Space saving: 1.800 x 598 x 717 (H x W x D)
- Reduced installation costs

- Piping at the bottom of the All in One (easy to install)
- Reduced installation time and minimised installation errors
- Easy remote controller to set up
- Electrical connections at the front
- Reduced installation spaces
- All piping connections at bottom of the indoor unit
- Easier installation and maintenance
- New remote controller functions



WH-UX09FE5  
WH-UX12FE5

Kit	Single Phase (Power to indoor)			Three Phase (Power to indoor)	
	KIT-ADC12GE5	KIT-ADC16GE5	KIT-ADC9GE8	KIT-ADC12GE8	KIT-ADC16GE8
Heating capacity at +7°C (heating water at 35°C)	kW	12,00	16,00	9,00	12,00
COP at +7°C (heating water at 35°C)	W/W	4,74	4,28	4,84	4,74
Heating capacity at +2°C (heating water at 35°C)	kW	11,40	13,00	9,00	11,40
COP at +2°C (heating water at 35°C)	W/W	3,44	3,28	3,59	3,44
Heating capacity at -7°C (heating water at 35°C)	kW	10,00	11,40	9,00	10,00
COP at -7°C (heating water at 35°C)	W/W	2,73	2,68	2,85	2,73
Cooling capacity at 35°C (cooling water at 7/12°C)	kW	10,00	12,20	7,00	10,00
EER at 35°C (cooling water at 7/12°C)	W/W	2,81	2,56	3,17	2,85
Energy Efficiency Class at 35°C / at 55°C / at 55°C for DHW		A++ / A+ / A	A++ / A+ / A	A++ / A+ / A	A++ / A+ / A
<b>Indoor Unit</b>		<b>WH-ADC1216G6E5</b>	<b>WH-ADC1216G6E5</b>	<b>WH-ADC0916G9E8</b>	<b>WH-ADC0916G9E8</b>
Sound pressure	Heating / Cooling	dB(A)	33 / 33	33 / 33	33 / 33
Dimensions / Net Weight	H x W x D	mm / kg	1.800 x 598 x 717 / —	1.800 x 598 x 717 / 139	1.800 x 598 x 717 / 139
Water pipe connector		mm	R 1 1/4	R 1 1/4	R 1 1/4
A class Pump	Number of speeds		7	7	7
	Input power (Min / Max)	W	36 / 152	36 / 152	36 / 152
Heating water flow (ΔT=5 K, 35°C)		l/min	34,4	45,9	25,8
Capacity of integrated electric heater		kW	6	6	9
Recommended Fuse		A	30 / 30	30 / 30	16 / 16
Recommended cable size, supply 1 & 2		mm <sup>2</sup>	3 x 4,0 / 3 x 4,0	3 x 4,0 / 3 x 4,0	5 x 1,5 / 5 x 1,5
Water volume		L	185	185	185
Maximum water temperature		°C	65	65	65
Material inside tank			Stainless steel	Stainless steel	Stainless steel
<b>Outdoor Unit</b>			<b>WH-UD12FE5</b>	<b>WH-UD16FE5</b>	<b>WH-UD09FE8</b>
Sound pressure	Heating / Cooling	dB(A)	52 / 50	55 / 54	51 / 49
Dimensions / Weight	H x W x D	mm / kg	1.340 x 900 x 320 / 101	1.340 x 900 x 320 / 101	1.340 x 900 x 320 / 108
Refrigerant (R410A)		kg	2,55	2,55	2,55
Pipe diameter	Liquid / Gas	Inch (mm)	3/8 (9,52) / 5/8 (15,88)	3/8 (9,52) / 5/8 (15,88)	3/8 (9,52) / 5/8 (15,88)
Pipe length range / Elevation difference (in/out)		m	3 - 30 / 20	3 - 30 / 20	3 - 30 / 20
Pipe length for additional gas / Additional gas amount		m / g/m	10 / 50	10 / 50	10 / 50
Operation range	Outdoor ambient	°C	-20 ~ +35	-20 ~ +35	-20 ~ +35
Water outlet	Heating / Cooling	°C	25 - 55 / 5 - 20	25 - 55 / 5 - 20	25 - 55 / 5 - 20

Accessories	
PAW-ADC-PREKIT	Pre installation kit for piping
PAW-ADC-CV150	Decorative magnetic side cover
PAW-BTANK50L	Buffer tank 50L
PA-AW-WIFI-1TE	Wifi interface

Accessories	
PAW-A2W-BIV	Bivalent control
PAW-FILTER	Filter
PAW-A2W-RTWIRED	Room thermostat

Kit	Single Phase (Power to indoor)	
	KIT-AXC9GE5	KIT-AXC12GE5
Heating capacity at +7°C (heating water at 35°C)	kW	9,00
COP at +7°C (heating water at 35°C)	W/W	4,84
Heating capacity at +2°C (heating water at 35°C)	kW	9,00
COP at +2°C (heating water at 35°C)	W/W	3,59
Heating capacity at -7°C (heating water at 35°C)	kW	9,00
COP at -7°C (heating water at 35°C)	W/W	2,85
Cooling capacity at 35°C (cooling water at 7/12°C)	kW	7,00
EER at 35°C (cooling water at 7/12°C)	W/W	3,17
Energy Efficiency Class at 35°C / at 55°C / at 55°C for DHW		A++ / A+ / A
<b>Indoor Unit</b>		<b>WH-ADC1216G6E5</b>
Sound pressure	Heating / Cooling	dB(A)
Dimensions / Net Weight	H x W x D	mm / kg
Water pipe connector		mm
A class Pump	Number of speeds	
	Input power (Min / Max)	W
Heating water flow (ΔT=5 K, 35°C)		l/min
Capacity of integrated electric heater		kW
Recommended Fuse		A
Recommended cable size, supply 1 & 2		mm <sup>2</sup>
Water volume		L
Maximum water temperature		°C
Material inside tank		Stainless steel
<b>Outdoor Unit</b>		<b>WH-UX09FE5</b>
Sound pressure	Heating / Cooling	dB(A)
Dimensions / Weight	H x W x D	mm / kg
Refrigerant (R410A)		kg
Pipe diameter	Liquid / Gas	Inch (mm)
Pipe length range / Elevation difference (in/out)		m
Pipe length for additional gas / Additional gas amount		m / g/m
Operation range	Outdoor ambient	°C
Water outlet	Heating / Cooling	°C

Accessories	
PAW-ADC-PREKIT	Pre installation kit for piping
PAW-ADC-CV150	Decorative magnetic side cover
PAW-BTANK50L	Buffer tank 50L
PA-AW-WIFI-1TE	Wifi interface

Accessories	
PAW-A2W-BIV	Bivalent control
PAW-FILTER	Filter
PAW-A2W-RTWIRED	Room thermostat

COP classification is at 230V only in accordance with EU directive 2003/32/EC. Sound pressure measured at 1m from the outdoor unit and at 1,5m height. Heating sound pressure measured at +7°C (heating water at 55°C). Performance in agreement with EN14511. 1) Insulated tested under EN12897.

COP classification is at 230V only in accordance with EU directive 2003/32/EC. Sound pressure measured at 1m from the outdoor unit and at 1,5m height. Heating sound pressure measured at +7°C (heating water at 55°C). Performance in agreement with EN14511. 1) Insulated tested under EN12897.



# AQUAREA H GENERATION HIGH PERFORMANCE BI-BLOC SINGLE PHASE / THREE PHASE. HEATING AND COOLING - SDC

The new H Generation are specially designed for low energy homes and achieve an impressive COP of 5 (on the 3,2kW).

Thanks to the system's high degree of technology and advanced control, it is able to maintain a high capacity and efficiency even at -7°C and -15°C. The Aquarea's software is optimised to the requirements of low consumption homes in order to maximise energy efficiency. Whatever the weather, Aquarea can work even at -20°C. The compact design of the outdoor unit makes installation very easy.

### Technical focus

- **NEW!** Touch Controller
- **NEW!** Indoor Unit
- Super efficient: COP of 5 in the 3,2kW!
- Very high energy savings A+++ (\*)
- Simple installation & maintenance
- Special software for low consumption homes with minimum output temperature: 20°C
- Works at temperatures as low as -20°C
- Automatic Air purge valve
- Display of the compressor frequency

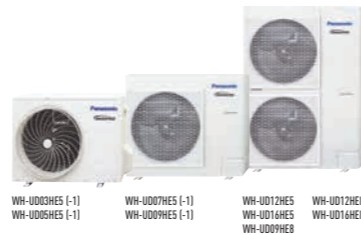

Kit	Single Phase Heating and Cooling					Three Phase (Power to indoor)				
	KIT-WC03H3E5	KIT-WC05H3E5	KIT-WC07H3E5	KIT-WC09H3E5	KIT-WC012H6E5 <sup>1</sup>	KIT-WC016H6E5 <sup>1</sup>	KIT-WC09H3E8 <sup>1</sup>	KIT-WC12H9E8 <sup>1</sup>	KIT-WC16H9E8 <sup>1</sup>	
Heating capacity at +7°C (heating water at 35°C)	3,20		5,00		7,00		9,00		12,00	
COP at +7°C (heating water at 35°C)	5,00		4,63		4,46		4,13		4,74	
Heating capacity at +2°C (heating water at 35°C)	3,20		4,20		6,55		6,70		11,40	
COP at +2°C (heating water at 35°C)	3,56		3,11		3,34		3,13		3,44	
Heating capacity at -7°C (heating water at 35°C)	3,20		4,20		5,15		5,90		10,00	
COP at -7°C (heating water at 35°C)	2,69		2,59		2,68		2,52		2,73	
Cooling capacity at 35°C (cooling water at 7/12°C)	3,20		4,50		6,00		7,00		10,00	
EER at 35°C (cooling water at 7/12°C)	3,08		2,69		2,63		2,43		2,81	
Energy Efficiency Class at 35°C / 55°C	A+++ / A++		A++ / A+		A+ / A		A / A-		A- / A-	
System label 35°C / 55°C <sup>2</sup>	A+++ / A++		A+++ / A++		A+++ / A++		A+++ / A++		A+++ / A++	
<b>Indoor Unit<sup>3</sup></b>	<b>WH-SDC03H3E5 (-1)</b>					<b>WH-SDC12H6E5</b>				
Sound pressure	28 / 28		28 / 28		30 / 30		33 / 33		33 / 33	
Dimensions / Weight	892 x 500 x 340 / 44		892 x 500 x 340 / 44		892 x 500 x 340 / 44		892 x 500 x 340 / 44		892 x 500 x 340 / 45	
Water pipe connector	R 1 1/4		R 1 1/4		R 1 1/4		R 1 1/4		R 1 1/4	
A class pump	Variable Speed		Variable Speed		Variable Speed		Variable Speed		Variable Speed	
Heating water flow [ΔT=5 K, 35°C]	30 / 100		33 / 106		34 / 114		40 / 120		34 / 110	
Capacity of integrated electric heater	3		3		3		3		3	
Recommended fuse	15 / 30		15 / 30		15 / 30		15 / 30		15 / 30	
Recommended cable size, supply 1 & 2	3 x 1,5 / 3 x 1,5		3 x 1,5 / 3 x 1,5		3 x 1,5 / 3 x 1,5		3 x 1,5 / 3 x 1,5		3 x 1,5 / 3 x 1,5	
<b>Outdoor Unit<sup>3</sup></b>	<b>WH-UD03HE5 (-1)</b>					<b>WH-UD12HE5</b>				
Sound pressure	47 / 47		48 / 48		50 / 48		51 / 50		55 / 54	
Dimensions / Weight	622 x 824 x 298 / 39		622 x 824 x 298 / 39		795 x 900 x 320 / 66		795 x 900 x 320 / 66		1.340 x 900 x 320 / 101	
Refrigerant (R410A)	1,20		1,20		1,45		1,45		2,55	
Pipe diameter	1/4 (6,35) / 1/2 (12,7)		1/4 (6,35) / 1/2 (12,7)		1/4 (6,35) / 5/8 (15,88)		1/4 (6,35) / 5/8 (15,88)		3/8 (9,52) / 5/8 (15,88)	
Pipe length range / Elevation difference (in/out)	3 - 15 / 5		3 - 15 / 5		3 - 30 / 20		3 - 30 / 20		3 - 30 / 20	
Operation range	-20 - +35		-20 - +35		-20 - +35		-20 - +35		-20 - +35	
Water outlet	20 - 55 / 5 - 20		20 - 55 / 5 - 20		25 - 55 / 5 - 20		25 - 55 / 5 - 20		25 - 55 / 5 - 20	

Accessories	
PAW-TD20C1E5	Tank 200L - Stainless steel
PAW-TD30C1E5	Tank 300L - Stainless steel
PAW-TG20C1E3STD-1	Tank 200L - Enamelled
PAW-TG30C1E3STD-1	Tank 300L - Enamelled
CZ-TK1	Temperature sensor for 3rd party tank

Accessories	
CZ-NV1	3 way valve Kit for inside of hydrokit
CZ-NS4P	Additional functions PCB
PAW-BTANK50L	Buffer tank 50L
CZ-TAW1	Aquarea Smart Cloud, H Generation Internet control through Wifi or wired LAN
PAW-A2W-RTWIRED	Room thermostat

COP classification is at 230V only in accordance with EU directive 2003/32/EC. Sound pressure measured at 1m from the outdoor unit and at 1,5m height. Performance in agreement with EN14511. Remark to energy efficiency class: These indications are based on the official ErP regulations (EU regulations N° 811/2013, EN 14511 and EN 14825) for heat pumps, which is officially binding from September 2015. Efficiency classes marked with \* would meet the new regulations from September 2019 to these indications as A+++.. 1) Available in April 2017. 2) System label with controller. 3) New references from March 2017: WH-SDC\_03H3E5-1 and WH-UD\_03HE5-1. \* Tentative data.



INTERNET CONTROL: Optional.	
Stainless steel	Enamelled

# AQUAREA H GENERATION T-CAP BI-BLOC SINGLE PHASE / THREE PHASE. HEATING AND COOLING - SXC

The best for extreme outdoor conditions. Constant capacity at -20°C.

Aquarea T-CAP can work in extreme outdoor conditions as low as -28°C and warranty the capacity without back up heating down to 20°C. Ready to work at extreme outdoor conditions the H Generation T-CAP can produce water up to 60°C, expanding its possibilities for retrofit application. H Generation is the quickest to install and easiest maintenance.

### Technical focus

- **NEW!** Touch Controller
- **NEW!** Indoor Unit
- Very high energy savings A++
- Simple installation & maintenance
- Constant capacity up to -20°C
- Water temperature up to 60°C
- Special software for low consumption homes with minimum output temperature: 20°C
- Works at temperatures as low as -28°C
- Automatic Air purge valve
- Display of the compressor frequency



Kit	Single Phase (Power to indoor)		Three Phase (Power to indoor)		
	KIT-WXC09H3E5 <sup>1</sup>	KIT-WXC12H6E5 <sup>1</sup>	KIT-WXC09H3E8	KIT-WXC12H9E8	KIT-WXC16H9E8
Heating capacity at +7°C (heating water at 35°C)	9,00		12,00		
COP at +7°C (heating water at 35°C)	4,84		4,74		
Heating capacity at +2°C (heating water at 35°C)	9,00		12,00		
COP at +2°C (heating water at 35°C)	3,59		3,44		
Heating capacity at -7°C (heating water at 35°C)	9,00		12,00		
COP at -7°C (heating water at 35°C)	2,85		2,72		
Cooling capacity at 35°C (cooling water at 7°C)	7,00		10,00		
EER at 35°C (cooling water at 7°C)	3,17		2,81		
Energy Efficiency Class at 35°C	A++		A++		
Energy Efficiency Class at 55°C	A++		A++		
<b>Indoor Unit</b>	<b>WH-SXC09H3E5</b>		<b>WH-SXC12H6E5</b>		
Sound pressure	33 / 33		33 / 33		
Dimensions / Weight*	892 x 500 x 340 / 43		892 x 500 x 340 / 43		
Water pipe connector	R 1 1/4		R 1 1/4		
Pump	Variable Speed		Variable Speed		
Number of speeds	32 / 102		34 / 110		
Input power (Min / Max)	W		W		
Heating water flow [ΔT=5 K, 35°C]	25,8		25,8		
Capacity of integrated electric heater	3		3		
Recommended Fuse	A		A		
Recommended cable size, supply 1 & 2	3 x 4,0 or 6,0 / 3 x 4,0		3 x 4,0 or 6,0 / 3 x 4,0		
<b>Outdoor Unit</b>	<b>WH-UX09HE5</b>		<b>WH-UX12HE8</b>		
Sound pressure	51 / 49		52 / 50		
Dimensions / Weight	1.340 x 900 x 320 / 101		1.340 x 900 x 320 / 108		
Refrigerant (R410A)	2,85		2,85		
Pipe diameter	3/8 (9,52) / 5/8 (15,88)		3/8 (9,52) / 5/8 (15,88)		
Pipe length range / Elevation difference (in/out)	3 - 30 / 20		3 - 30 / 20		
Operation range	-28 - +35		-28 - +35		
Water outlet	25 - 60 / 5 - 20		25 - 60 / 5 - 20		

Accessories	
PAW-TD20C1E5	Tank 200L - Stainless steel
PAW-TD30C1E5	Tank 300L - Stainless steel
PAW-TG20C1E3STD-1	Tank 200L - Enamelled
PAW-TG30C1E3STD-1	Tank 300L - Enamelled
CZ-TK1	Temperature sensor for 3rd party tank

Accessories	
CZ-NV1	3 way valve Kit for inside of hydrokit
CZ-NS4P	Additional functions PCB
PAW-BTANK50L	Buffer tank 50L
CZ-TAW1	Aquarea Smart Cloud, H Generation Internet control through Wifi or wired LAN
PAW-A2W-RTWIRED	Room thermostat

COP classification is at 230V only in accordance with EU directive 2003/32/EC. Sound pressure measured at 1m from the outdoor unit and at 1,5m height. Heating sound pressure measured at +7°C (heating water at 55°C). Performance in agreement with EN14511. 1) Available in April 2017. \* Tentative data.



INTERNET CONTROL: Optional.	
Stainless steel	Enamelled



# AQUAREA H GENERATION T-CAP BI-BLOC THREE PHASE. SUPER QUIET OUTDOOR UNIT. HEATING AND COOLING - SXC

The best for extreme outdoor conditions.  
Constant capacity at -20°C.

Aquarea T-CAP can work in extreme outdoor conditions as low as -28°C and warranty the capacity without back up heating down to 20°C. Ready to work at extreme outdoor conditions the H Generation T-CAP can produce water up to 60°C, expanding its possibilities for retrofit application. H Generation is the quickest to install and easiest maintenance.

### Technical focus

- **NEW!** Touch Controller
- **NEW!** Indoor Unit
- Very high energy savings A++
- Noise reduction of 7dB is based on power level when heating mode
- With Quite mode we can reach 10 ~ 12dB(A)
- Simple installation & maintenance
- Constant capacity up to -20°C
- Water temperature up to 60°C
- Special software for low consumption homes with minimum output temperature: 20°C
- Works at temperatures as low as -28°C
- Automatic Air purge valve
- Display of the compressor frequency



Kit	Three Phase. New Super Quiet outdoor unit		
	KIT-WOC09H3E8	KIT-WOC12H9E8	KIT-WOC16H9E8
Heating capacity at +7°C (heating water at 35°C)	9,00	12,00	16,00
COP at +7°C (heating water at 35°C)	4,84	4,74	4,28
Heating capacity at +2°C (heating water at 35°C)	9,00	12,00	16,00
COP at +2°C (heating water at 35°C)	3,59	3,44	3,10
Heating capacity at -7°C (heating water at 35°C)	9,00	10,00	11,40
COP at -7°C (heating water at 35°C)	2,85	2,73	2,68
Cooling capacity at 35°C (cooling water at 7°C)	7,00	10,00	12,20
EER at 35°C (cooling water at 7°C)	3,17	2,81	2,57
Energy Efficiency Class at 35°C	A++	A++	A++
Energy Efficiency Class at 55°C	A++	A++	A++
<b>Indoor Unit</b>	<b>WH-SOC09H3E8</b>	<b>WH-SOC12H9E8</b>	<b>WH-SOC16H9E8</b>
Sound pressure	33 / 33	33 / 33	33 / 33
Dimensions / Weight*	892 x 500 x 340 / 43	892 x 500 x 340 / 44	892 x 500 x 340 / 45
Water pipe connector	R 1 1/4	R 1 1/4	R 1 1/4
Pump	Number of speeds	Variable Speed	Variable Speed
	Input power (Min / Max)	32 / 102	34 / 110
Heating water flow (ΔT=5 K, 35°C)	25,8	34,4	45,9
Capacity of integrated electric heater	3	9	9
Recommended Fuse	15 / 30	15 / 30	15 / 30
Recommended cable size, supply 1 & 2	3 x 1,5 / 3 x 1,5	3 x 1,5 / 3 x 1,5	3 x 1,5 / 3 x 1,5
<b>Outdoor Unit</b>	<b>WH-U009HE8</b>	<b>WH-U012HE8</b>	<b>WH-U016HE8</b>
Sound pressure	47 / 48	48 / 49	51 / 53
Dimensions / Weight	1.410 x 1.283 x 320 / 151	1.410 x 1.283 x 320 / 151	1.410 x 1.283 x 320 / 161
Refrigerant (R410A)	2,85	2,85	2,99
Pipe diameter	3/8 (9,52) / 5/8 (15,88)	3/8 (9,52) / 5/8 (15,88)	3/8 (9,52) / 5/8 (15,88)
Pipe length range / Elevation difference (in/out)	3 - 30 / 20	3 - 30 / 20	3 - 30 / 20
Pipe length for additional gas / Additional gas amount	10 / 50	10 / 50	10 / 50
Operation range	-28 ~ +35	-28 ~ +35	-28 ~ +35
Water outlet	Heating / Cooling	25 - 60 / 5 - 20	25 - 60 / 5 - 20

Accessories	
PAW-TD20C1E5	Tank 200L - Stainless steel
PAW-TD30C1E5	Tank 300L - Stainless steel
PAW-TG20C1E3STD-1	Tank 200L - Enamelled
PAW-TG30C1E3STD-1	Tank 300L - Enamelled
CZ-TK1	Temperature sensor for 3rd party tank

Accessories	
CZ-NV1	3 way valve Kit for inside of hydrokit
CZ-NS4P	Additional functions PCB
PAW-BTANK50L	Buffer tank 50L
CZ-TAW1	Aquarea Smart Cloud, H Generation Internet control through Wifi or wired LAN
PAW-A2W-RTWIRED	Room thermostat

COP classification is at 230V only in accordance with EU directive 2003/32/EC. Sound pressure measured at 1m from the outdoor unit and at 1,5m height. Heating sound pressure measured at +7°C (heating water at 55°C). Performance in agreement with EN14511. 1) Available in April 2017. \* Tentative data.

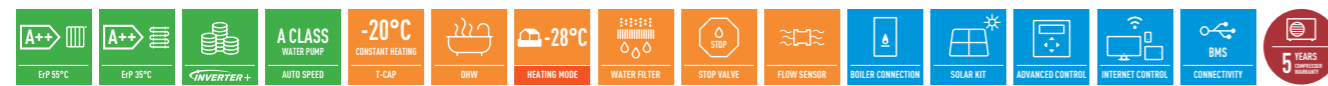

INTERNET CONTROL: Optional.

# AQUAREA HT BI-BLOC SINGLE PHASE / THREE PHASE. HEATING ONLY - SHF

Aquarea HT is able to deliver water heated to 65°C with the Heat Pump alone.

For a house with high temperature radiators (for example, cast iron radiators), the Aquarea High Temperature Solution is the most suited as it provides output water temperatures of 65°C even at -20°C.

### Technical focus

- New remote controller functions
- Efficient control of room temperature based on the outdoor temperature, indoor temperature using the Aquarea Manager.
- Optional Smartphone control
- Range from 9 to 12kW, Single and Three Phase
- Maximum hydraulic module output temperature: 65°C
- Works at temperatures as low as -20°C
- Maximum 20m rise between the outdoor unit and the hydraulic module



Kit	Single Phase (Power to indoor)		Three Phase (Power to indoor)	
	KIT-WHF09F3E5	KIT-WHF12F6E5	KIT-WHF09F3E8	KIT-WHF12F9E8
Heating capacity at +7°C (heating water at 35°C)	9,00	12,00	9,00	12,00
COP at +7°C (heating water at 35°C)	4,64	4,46	4,64	4,46
Heating capacity at +2°C (heating water at 35°C)	9,00	12,00	9,00	12,00
COP at +2°C (heating water at 35°C)	3,45	3,26	3,45	3,26
Heating capacity at -7°C (heating water at 35°C)	9,00	12,00	9,00	12,00
COP at -7°C (heating water at 35°C)	2,74	2,52	2,74	2,52
Heating capacity at +7°C (heating water at 65°C)	9,00	12,00	9,00	12,00
COP at +7°C (heating water at 65°C)	2,27	2,22	2,29	2,22
Heating capacity at +2°C (heating water at 65°C)	9,00	10,30	9,00	10,30
COP at +2°C (heating water at 65°C)	1,89	1,84	1,89	1,84
Heating capacity at -7°C (heating water at 65°C)	8,90	9,60	8,90	9,60
COP at -7°C (heating water at 65°C)	1,63	1,62	1,63	1,62
Energy Efficiency Class at 35°C	A++	A++	A++	A++
Energy Efficiency Class at 55°C	A++	A++	A++	A++
<b>Indoor Unit</b>	<b>WH-SHF09F3E5</b>	<b>WH-SHF12F6E5</b>	<b>WH-SHF09F3E8</b>	<b>WH-SHF12F9E8</b>
Sound pressure	33	33	33	33
Dimensions / Weight	892 x 502 x 353 / 46	892 x 502 x 353 / 47	892 x 502 x 353 / 47	892 x 502 x 353 / 48
Water pipe connector	R 1 1/4	R 1 1/4	R 1 1/4	R 1 1/4
Pump	Number of speeds	7	7	7
	Input power (Min / Max)	38 / 100	40 / 106	38 / 100
Heating water flow (ΔT=5 K, 35°C)	25,8	34,4	25,8	34,4
Capacity of integrated electric heater	3	6	3	9
Recommended Fuse	30 / 30	30 / 30	30 / 16	30 / 16
Recommended cable size, supply 1 & 2	3 x 4,0 or 6,0 / 3 x 4,0	3 x 4,0 or 6,0 / 3 x 4,0	5 x 1,5 / 3 x 1,5	5 x 1,5 / 5 x 1,5
<b>Outdoor Unit</b>	<b>WH-UH09FE5</b>	<b>WH-UH12FE5</b>	<b>WH-UH09FE8</b>	<b>WH-UH12FE8</b>
Sound pressure	51	52	51	52
Dimensions / Weight	1.340 x 900 x 320 / 104	1.340 x 900 x 320 / 104	1.340 x 900 x 320 / 110	1.340 x 900 x 320 / 110
Refrigerant (R407C)	2,90	2,90	2,90	2,90
Pipe diameter	3/8 (9,52) / 5/8 (15,88)	3/8 (9,52) / 5/8 (15,88)	3/8 (9,52) / 5/8 (15,88)	3/8 (9,52) / 5/8 (15,88)
Pipe length range / Elevation difference (in/out)	3 - 30 / 20	3 - 30 / 20	3 - 30 / 20	3 - 30 / 20
Pipe length for additional gas / Additional gas amount	10 / 70	10 / 70	10 / 70	10 / 70
Operation range	-20 ~ +35	-20 ~ +35	-20 ~ +35	-20 ~ +35
Water outlet	25 - 65	25 - 65	25 - 65	25 - 65

Accessories	
PAW-TD20C1E5	Tank 200L - Stainless steel
PAW-TD30C1E5	Tank 300L - Stainless steel
PAW-TG20C1E3STD-1	Tank 200L - Enamelled
PAW-TG30C1E3STD-1	Tank 300L - Enamelled
CZ-TK1	Temperature sensor for 3rd party tank
PAW-3WYVIV-SI	3 way valve

Accessories	
PAW-BTANK50L	Buffer tank 50L
PA-AW-WIFI-1TE	Wifi interface
PAW-A2W-BIV	Bivalent control
PAW-FILTER	Filter
PAW-A2W-RTWIRED	Room thermostat

COP classification is at 230V only in accordance with EU directive 2003/32/EC. Sound pressure measured at 1m from the outdoor unit and at 1,5m height. Heating sound pressure measured at +7°C (heating water at 55°C). Performance in agreement with EN14511.



INTERNET CONTROL: Optional.

## AQUAREA H GENERATION HIGH PERFORMANCE MONO-BLOC SINGLE PHASE. HEATING AND COOLING - MDC

The Aquarea MDC range adapts well in an existing installation with a boiler backup, and in a new application with underfloor heating, low temperature radiators or even fan-coil heaters.

This range can also be connected to a solar kit in order to increase efficiency and minimise the impact on the ecosystem. Finally, it is possible to connect a thermostat for even better heating and cooling control and management.

Whatever the weather, Aquarea can work even at -20°C. The Mono-bloc is easy to install in new and existing residential properties.



### Technical focus

- **NEW!** Touch Controller
- Optional Smartphone control
- Range from 5 to 9kW, Single Phase
- Maximum hydraulic module output temperature: 55°C
- Works at temperatures as low as -20°C
- Cooling temperature range 5 ~ 20°C

		Single Phase Heating and Cooling		
Outdoor Unit		WH-MDC05H3E5 <sup>1</sup>	WH-MDC07H3E5 <sup>1</sup>	WH-MDC09H3E5 <sup>1</sup>
Heating capacity at +7°C (heating water at 35°C)	kW	5,00	7,00	9,00
COP at +7°C (heating water at 35°C)	W/W	5,08	4,46	4,15
Heating capacity at +2°C (heating water at 35°C)	kW	4,80	7,45	11,40
COP at +2°C (heating water at 35°C)	W/W	3,75	3,45	3,14
Heating capacity at -7°C (heating water at 35°C)	kW	4,50	5,15	7,70
COP at -7°C (heating water at 35°C)	W/W	2,98	2,68	2,12
Cooling capacity at 35°C (cooling water at 7°C)	kW	4,50	5,50	7,00
EER at 35°C (cooling water at 7°C)	W/W	3,33	2,74	2,44
Energy Efficiency Class at 35°C		A++	A++	A++
Energy Efficiency Class at 55°C		A++	A++	A++
Sound pressure	Heating / Cooling	49 / 47	49 / 47	51 / 49
Sound power level	Heating / Cooling	65 / 65	65 / 65	69 / 67
Dimensions	H x W x D	865 x 1.283 x 320	865 x 1.283 x 320	865 x 1.283 x 320
Weight	kg	107	112	112
Refrigerant (R410A) <sup>2</sup>	kg	1,42	1,45	1,45
Water pipe connector		R 1 1/4	R 1 1/4	R 1 1/4
Pump	Number of speeds	7	7	7
	Input power (Min / Max)	34 / 96	36 / 100	39 / 108
Heating water flow (ΔT=5 K, 35°C)	l/min	14,3	17,2	25,8
Capacity of integrated electric heater	kW	3	3	3
Input Power	Heating	0,985	1,34	2,17
	Cooling	1,35	2,01	2,87
Running and Starting current	Heating	4,5	6,1	9,9
	Cooling	6,1	9,3	13,0
Current 1	A	19,5	20,5	22,9
Current 2	A	13,0	13,0	13,0
Recommended Fuse	A	30 / 15	30 / 15	30 / 16
Recommended cable size, supply 1 & 2	mm <sup>2</sup>	3 x 4,0 or 6,0 / 3 x 4,0	3 x 4,0 or 6,0 / 3 x 4,0	3 x 4,0 or 6,0 / 3 x 4,0
Operation range	Outdoor ambient	°C	-20 ~ +35	-20 ~ +35
	Heating	°C	20 ~ 55	20 ~ 55
Water outlet	Heating	°C	20 ~ 55	20 ~ 55
	Cooling	°C	5 ~ 20	5 ~ 20

Accessories	
PAW-TD20C1E5	Tank 200L - Stainless steel
PAW-TD30C1E5	Tank 300L - Stainless steel
PAW-TG20C1E3STD-1	Tank 200L - Enamelled
PAW-TG30C1E3STD-1	Tank 300L - Enamelled
CZ-TK1	Temperature sensor for 3rd party tank
PAW-3WYVLV-SI	3 way valve

Accessories	
PAW-BTANK50L	Buffer tank 50L
PA-AW-WIFI-1TE	Wifi interface
PAW-A2W-BIV	Bivalent control
PAW-A2W-RTWIRED	Room thermostat

COP classification is at 230V only in accordance with EU directive 2003/32/EC. Sound pressure measured at 1m from the outdoor unit and at 1,5m height. Heating sound pressure measured at +7°C (heating water at 55°C). Performance in agreement with EN14511. Authorized service partner or Authorized installer can enable the cooling mode through a special operation via the remote controller on site. 1) Available in October 2017. 2) WH-MDC models are hermetically sealed. \* Tentative data.



INTERNET CONTROL: Optional.

## AQUAREA G GENERATION HIGH PERFORMANCE MONO-BLOC SINGLE PHASE. HEATING AND COOLING - MDC

The Aquarea MDC range adapts well in an existing installation with a boiler backup, and in a new application with underfloor heating, low temperature radiators or even fan-coil heaters.

This range can also be connected to a solar kit in order to increase efficiency and minimise the impact on the ecosystem. Finally, it is possible to connect a thermostat for even better heating and cooling control and management.

Whatever the weather, Aquarea can work even at -20°C. The Mono-bloc is easy to install in new and existing residential properties.



### Technical focus

- Efficient control of room temperature based on the outdoor temperature, indoor temperature using the Aquarea Manager.
- Optional Smartphone control
- Range from 5 to 16kW, Single Phase
- Maximum hydraulic module output temperature: 55°C
- Works at temperatures as low as -20°C
- Cooling temperature range 5 ~ 20°C
- Plug and play system (WH-MDC05F3E5)

		Single Phase Heating and Cooling				
Outdoor Unit		WH-MDC05F3E5	WH-MDC06G3E5	WH-MDC09G3E5	WH-MDC12G6E5	WH-MDC16G6E5
Heating capacity at +7°C (heating water at 35°C)	kW	5,00	6,00	9,00	12,00	16,00
COP at +7°C (heating water at 35°C)	W/W	5,08	4,46	4,15	4,74	4,28
Heating capacity at +2°C (heating water at 35°C)	kW	4,80	5,00	7,45	11,40	13,00
COP at +2°C (heating water at 35°C)	W/W	3,75	3,45	3,14	3,44	3,28
Heating capacity at -7°C (heating water at 35°C)	kW	4,50	5,15	7,70	10,00	11,40
COP at -7°C (heating water at 35°C)	W/W	2,98	2,68	2,12	2,73	2,68
Cooling capacity at 35°C (cooling water at 7°C)	kW	4,50	5,50	7,00	10,00	12,20
EER at 35°C (cooling water at 7°C)	W/W	3,33	2,74	2,44	2,81	2,56
Energy Efficiency Class at 35°C		A++	A++	A++	A++	A++
Energy Efficiency Class at 55°C		A++	A++	A++	A++	A++
Sound pressure	Heating / Cooling	49 / 47	49 / 47	51 / 49	52 / 50	55 / 54
Sound power level	Heating / Cooling	65 / 65	65 / 65	69 / 67	69 / 68	72 / 72
Dimensions	H x W x D	865 x 1.283 x 320	865 x 1.283 x 320	865 x 1.283 x 320	1.410 x 1.283 x 320	1.410 x 1.283 x 320
Weight	kg	107	112	112	147	147
Refrigerant (R410A) <sup>1</sup>	kg	1,42	1,45	1,45	2,10	2,10
Water pipe connector		R 1 1/4	R 1 1/4	R 1 1/4	R 1 1/4	R 1 1/4
Pump	Number of speeds	7	7	7	7	7
	Input power (Min / Max)	34 / 96	36 / 100	39 / 108	34 / 110	38 / 120
Heating water flow (ΔT=5 K, 35°C)	l/min	14,3	17,2	25,8	34,4	45,9
Capacity of integrated electric heater	kW	3	3	3	6	6
Input Power	Heating	0,985	1,34	2,17	2,53	3,74
	Cooling	1,35	2,01	2,87	3,56	4,76
Running and Starting current	Heating	4,5	6,1	9,9	11,7	17,3
	Cooling	6,1	9,3	13,0	16,5	22,0
Current 1	A	19,5	20,5	22,9	24,0	26,0
Current 2	A	13,0	13,0	13,0	26,0	26,0
Recommended Fuse	A	30 / 15	30 / 16	30 / 16	30 / 30	30 / 30
Recommended cable size, supply 1 & 2	mm <sup>2</sup>	3 x 4,0 or 6,0 / 3 x 4,0	3 x 4,0 or 6,0 / 3 x 4,0	3 x 4,0 or 6,0 / 3 x 4,0	3 x 4,0 or 6,0 / 3 x 4,0	3 x 4,0 or 6,0 / 3 x 4,0
Operation range	Outdoor ambient	°C	-20 ~ +35	-20 ~ +35	-20 ~ +35	-20 ~ +35
	Heating	°C	20 ~ 55	20 ~ 55	20 ~ 55	25 ~ 55
Water outlet	Heating	°C	20 ~ 55	20 ~ 55	25 ~ 55	25 ~ 55
	Cooling	°C	5 ~ 20	5 ~ 20	5 ~ 20	5 ~ 20

Accessories	
PAW-TD20C1E5	Tank 200L - Stainless steel
PAW-TD30C1E5	Tank 300L - Stainless steel
PAW-TG20C1E3STD-1	Tank 200L - Enamelled
PAW-TG30C1E3STD-1	Tank 300L - Enamelled
CZ-TK1	Temperature sensor for 3rd party tank
PAW-3WYVLV-SI	3 way valve

Accessories	
PAW-BTANK50L	Buffer tank 50L
PA-AW-WIFI-1TE	Wifi interface
PAW-A2W-BIV	Bivalent control
PAW-FILTER	Filter
PAW-A2W-RTWIRED	Room thermostat

COP classification is at 230V only in accordance with EU directive 2003/32/EC. Sound pressure measured at 1m from the outdoor unit and at 1,5m height. Heating sound pressure measured at +7°C (heating water at 55°C). Performance in agreement with EN14511. Authorized service partner or Authorized installer can enable the cooling mode through a special operation via the remote controller on site. 1) WH-MDC models are hermetically sealed.



INTERNET CONTROL: Optional.

# AQUAREA G GENERATION T-CAP MONO-BLOC SINGLE PHASE / THREE PHASE. HEATING AND COOLING - MXC

The MXC is ideal for residential properties which don't have an external boiler and require a maintained capacity level.

T-CAP stands for Total Capacity. This line-up is able to maintain the same nominal capacity even at -15°C without the help of an electrical booster heater. T-CAP is also able to provide extremely high efficiency, regardless of the outside temperature or the water temperature. The MXC adapts well in an existing installation with a boiler backup, and in a new application with underfloor heating, low temperature radiators or even fan-coil heaters. This range can also be connected to a

solar kit in order to increase efficiency and minimise the impact on the ecosystem. Finally, it is possible to connect a thermostat for even better heating or cooling control and management.

### Technical focus

- Efficient control of room temperature based on the outdoor temperature, indoor temperature using the Aquarea Manager.
- Optional Smartphone control
- Range from 9 to 16 kW, Single and Three Phase
- Maximum hydraulic module output temperature: 55°C
- Works at temperatures as low as -20°C
- Cooling temperature range 5 ~ 20°C

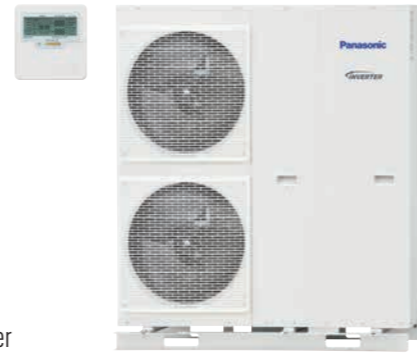

Outdoor Unit	Single Phase			Three Phase	
	WH-MXC09G3E5	WH-MXC12G6E5	WH-MXC09G3E8	WH-MXC12G9E8	WH-MXC16G9E8
Heating capacity at +7°C (heating water at 35°C)	kW	9,00	12,00	9,00	12,00
COP at +7°C (heating water at 35°C)	W/W	4,84	4,74	4,84	4,74
Heating capacity at +2°C (heating water at 35°C)	kW	9,00	12,00	9,00	12,00
COP at +2°C (heating water at 35°C)	W/W	3,59	3,44	3,59	3,44
Heating capacity at -7°C (heating water at 35°C)	kW	9,00	12,00	9,00	12,00
COP at -7°C (heating water at 35°C)	W/W	2,85	2,72	2,85	2,72
Cooling capacity at 35°C (cooling water at 7°C)	kW	7,00	10,00	7,00	10,00
EER at 35°C (cooling water at 7°C)	W/W	3,17	2,81	3,17	2,56
Energy Efficiency Class at 35°C		A++	A++	A++	A++
Energy Efficiency Class at 55°C		A++	A++	A++	A++
Sound pressure	Heating / Cooling	dB(A)	51 / 49	52 / 50	51 / 49
Sound power level	Heating / Cooling	dB	68 / 67	69 / 68	68 / 67
Dimensions	H x W x D	mm	1.410 x 1.283 x 320	1.410 x 1.283 x 320	1.410 x 1.283 x 320
Weight		kg	148	155	168
Refrigerant (R410A) <sup>1)</sup>		kg	2,30	2,30	2,55
Water pipe connector			R 1 1/4	R 1 1/4	R 1 1/4
Pump	Number of speeds		7	7	7
	Input power (Min / Max)	W	32 / 102	34 / 110	32 / 102
Heating water flow (ΔT=5 K, 35°C)		l/min	25,8	34,4	25,8
Capacity of integrated electric heater		kW	3	6	3
Input Power	Heating	kW	1,86	2,53	1,86
	Cooling	kW	2,21	3,56	2,21
Running and Starting current	Heating	A	8,6	11,7	2,8
	Cooling	A	10,2	16,5	3,4
Current 1		A	25,0	29,0	14,7
Current 2		A	13,0	26,0	13,0
Recommended Fuse		A	30 / 30	30 / 30	16 / 16
Recommended cable size, supply 1 & 2		mm <sup>2</sup>	3 x 4,0 or 6,0 / 3 x 4,0	3 x 4,0 or 6,0 / 3 x 4,0	5 x 1,5 / 3 x 1,5
Operation range	Outdoor ambient	°C	-20 ~ +35	-20 ~ +35	-20 ~ +35
	Heating	°C	25 ~ 55	25 ~ 55	25 ~ 55
Water outlet	Heating	°C	5 ~ 20	5 ~ 20	5 ~ 20
	Cooling	°C	5 ~ 20	5 ~ 20	5 ~ 20

Accessories	
PAW-TD20C1E5	Tank 200L - Stainless steel
PAW-TD30C1E5	Tank 300L - Stainless steel
PAW-TG20C1E3STD-1	Tank 200L - Enamelled
PAW-TG30C1E3STD-1	Tank 300L - Enamelled
CZ-TK1	Temperature sensor for 3rd party tank
PAW-3WYVLV-SI	3 way valve

Accessories	
PAW-BTANK50L	Buffer tank 50L
PA-AW-WIFI-1TE	Wifi interface
PAW-A2W-BIV	Bivalent control
PAW-FILTER	Filter
PAW-A2W-RTWIRED	Room thermostat

COP classification is at 230V only in accordance with EU directive 2003/32/EC. Sound pressure measured at 1m from the outdoor unit and at 1,5m height. Heating sound pressure measured at +7°C (heating water at 55°C). Performance in agreement with EN14511. 1) WH-MXC models are hermetically sealed.



INTERNET CONTROL: Optional.

# AQUAREA G GENERATION HT MONO-BLOC SINGLE PHASE. HEATING ONLY - MHF

Aquarea HT is able to deliver 65°C with the Heat Pump alone.

For a house with high temperature radiators (for example, cast iron radiators), the Aquarea High Temperature Solution is most suited as it provides output water temperatures of 65°C even at -20°C.

### Technical focus

- Efficient control of room temperature based on the outdoor temperature, indoor temperature using the Aquarea Manager.
- Optional Smartphone control
- Range from 9 to 12kW, Single and Three Phase
- Maximum hydraulic module output temperature: 65°C
- Works at temperatures as low as -20°C



Outdoor Unit	Single Phase	
	WH-MHF09G3E5	WH-MHF12G6E5
Heating capacity at +7°C (heating water at 35°C)	kW	9,00
COP at +7°C (heating water at 35°C)	W/W	4,64
Heating capacity at +2°C (heating water at 35°C)	kW	9,00
COP at +2°C (heating water at 35°C)	W/W	3,45
Heating capacity at -7°C (heating water at 35°C)	kW	9,00
COP at -7°C (heating water at 35°C)	W/W	2,74
Heating capacity at +7°C (heating water at 65°C)	kW	9,00
COP at +7°C (heating water at 65°C)	W/W	2,27
Heating capacity at +2°C (heating water at 65°C)	kW	9,00
COP at +2°C (heating water at 65°C)	W/W	1,89
Heating capacity at -7°C (heating water at 65°C)	kW	8,90
COP at -7°C (heating water at 65°C)	W/W	1,63
Energy Efficiency Class at 35°C		A++
Energy Efficiency Class at 55°C		A++
Sound pressure	dB(A)	51
Sound power level	dB	68
Dimensions	H x W x D	mm
Weight	kg	151
Refrigerant (R407C) <sup>1)</sup>	kg	1,92
Water pipe connector		R 1 1/4
Pump	Number of speeds	
	Input power (Min / Max)	W
Heating water flow (ΔT=5 K, 35°C)	l/min	25,8
Capacity of integrated electric heater	kW	3
Input Power	kW	1,94
Running and Starting current	A	9,3
Current 1	A	28,5
Current 2	A	13,0
Recommended Fuse	A	30 / 30
Recommended cable size, supply 1 & 2	mm <sup>2</sup>	3 x 4,0 or 6,0 / 3 x 4,0
Operation range	Outdoor ambient	°C
Water outlet		°C

Accessories	
PAW-TD20C1E5	Tank 200L - Stainless steel
PAW-TD30C1E5	Tank 300L - Stainless steel
PAW-TG20C1E3STD-1	Tank 200L - Enamelled
PAW-TG30C1E3STD-1	Tank 300L - Enamelled
CZ-TK1	Temperature sensor for 3rd party tank
PAW-3WYVLV-SI	3 way valve

Accessories	
PAW-BTANK50L	Buffer tank 50L
PA-AW-WIFI-1TE	Wifi interface
PAW-A2W-BIV	Bivalent control
PAW-FILTER	Filter
PAW-A2W-RTWIRED	Room thermostat

COP classification is at 230V only in accordance with EU directive 2003/32/EC. Sound pressure measured at 1m from the outdoor unit and at 1,5m height. Heating sound pressure measured at +7°C (heating water at 55°C). Performance in agreement with EN14511. 1) WH-MHF models are hermetically sealed.



INTERNET CONTROL: Optional.

# AQUAREA AIR RADIATORS FAN COILS FOR HEAT PUMP APPLICATION

AQUAREA  
AIR

## New line up of Super low temperature radiators for Heat Pump application: Aquarea Air 200/700/900 with radiating effect

The slimline Panasonic Aquarea Air radiators deliver high efficiency climate control. With a depth of just under 13 cm they are at the cutting edge of the market. Blending easily into the home, Aquarea Air's elegant design and product refinements are clear to see in every detail. The Aquarea Air's slimline profile has been achieved thanks to the innovative layout of the ventilation unit and the heat exchanger. The fan is tangential with asymmetric blades and the large surface heat exchanger enables high airflows to be achieved with low pressure loss and low noise levels. Exceptional ventilation efficiency means the motor uses considerably less energy (low wattage). The fan speed is continuously modulated by the temperature controller with proportional integral logic, with undoubted advantages for regulating the temperature and humidity in summer mode.



## Line up of super low temperature radiators for Heat Pump application

During winter, the operating principle is based on micro fans with very low power consumption and minimum noise, that send hot air coming from the heat exchanger, to the inside of the front panel of the device and therefore heat it effectively. With this principle, the terminal also provides significant power while heating, without running the main fan. Comfort temperatures are therefore maintained, without air movements and in silence. In summer mode, the airflow generated by the micro fans is stopped to avoid any dew formation on the terminal's front surface.

### Technical focus

- Front panel heating with radiant effect
- High heating capacity (without main fan running)
- 4 fan speeds and capacities
- Exclusive design
- Extremely compact (only 12,9 cm deep)
- Cooling and dehumidification functions possible (drain is needed)
- 3-way valve included (no overflow valve needed on the installation if more than 3 radiators installed)
- Touch screen thermostat

All temperature curves and capacity are available on [www.panasonicproclub.com](http://www.panasonicproclub.com)

During winter, the operating principle is based on micro fans with very low power consumption and minimum noise, that send hot air coming from the heat exchanger, to the inside of the front panel of the device and therefore heat it effectively.

With this principle, the terminal also provides significant power while heating, without running the main fan. Comfort temperatures are therefore maintained, without air movements and in silence. In summer mode, the airflow generated by the micro fans is stopped to avoid any dew formation on the terminal's front surface.

### Technical focus

- Front panel heating with radiant effect
- High heating capacity (without main fan running)
- 4 fan speeds and capacities
- Exclusive design
- Extremely compact (only 12,9cm deep)
- Cooling and dehumidification functions possible (drain is needed)
- 3-way valve included (no overflow valve needed on the installation if more than 3 radiators installed)
- Touch screen thermostat

Operating on heating mode with radiator using only radiant effect

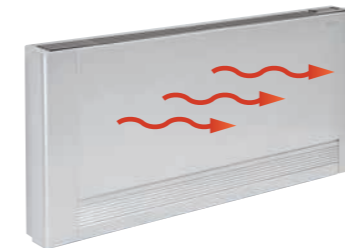

Operating on heating mode with radiant effect and fan mode

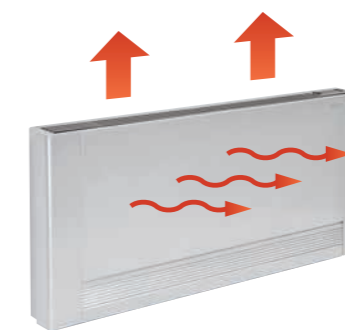

Operating on cooling mode with fan

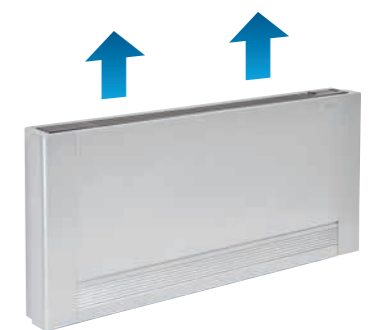

With standard cast radiators

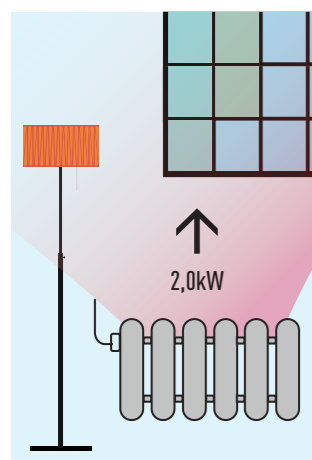

Water at 65°C needed.

With Aquarea Air

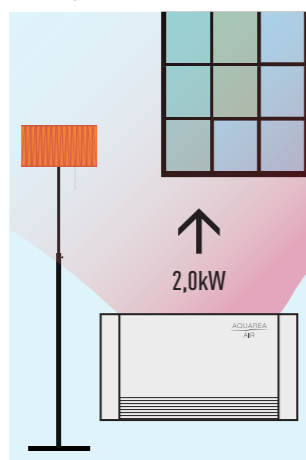

Water at 35°C needed.

Fan Coils for Heat Pump application	PAW-AAIR-200-1					PAW-AAIR-700-1					PAW-AAIR-900-1					
Total heating capacity	W	138	160	217	470	570	223	360	708	1.032	1.188	273	475	886	1.420	1.703
Water flow	kg/h	23,7	27,5	37,3	80,8	98,0	38,4	61,9	121,8	177,5	204,3	47,0	81,7	152,4	244,2	292,9
Water pressure drop	kPa	0,1	0,2	0,4	2,0	2,9	0,1	0,1	0,3	0,8	1,0	0,1	0,2	0,5	1,6	2,2
Air flow	m <sup>3</sup> /min	0,5	0,6	0,9	1,9	2,7	0,7	1,4	2,6	4,2	5,3	0,9	1,8	4,1	6,1	7,7
Maximum input power	Speed	Main Fan Off	Super Min	Min	Med	Max	Main Fan Off	Super Min	Min	Med	Max	Main Fan Off	Super Min	Min	Med	Max
	W	2	5	7	9	13	3	9	14	18	22	3	11	16	20	24
Sound pressure	dB(A)	17,6	18,8	24,7	33,2	39,4	18,4	19,6	25,8	34,1	40,2	18,4	22,3	26,2	34,4	42,2
Inlet water temperature	°C	35	35	35	35	35	35	35	35	35	35	35	35	35	35	35
Outlet water temperature	°C	30	30	30	30	30	30	30	30	30	30	30	30	30	30	30
Inlet air temperature	°C	19	19	19	19	19	19	19	19	19	19	19	19	19	19	19
Outlet air temperature	°C	34,5	32,6	38,9	32,0	30,0	34,9	32,4	33,3	31,8	30,6	34,8	32,5	30,2	31,1	30,6
Dimensions (H x W x D)	mm	579 x 735 x 129					579 x 935 x 129					579 x 1.135 x 129				
Weight	kg	17					20					23				
3-ways valve included		Yes					Yes					Yes				
Touch screen thermostat		Yes					Yes					Yes				

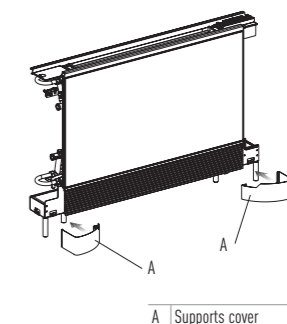
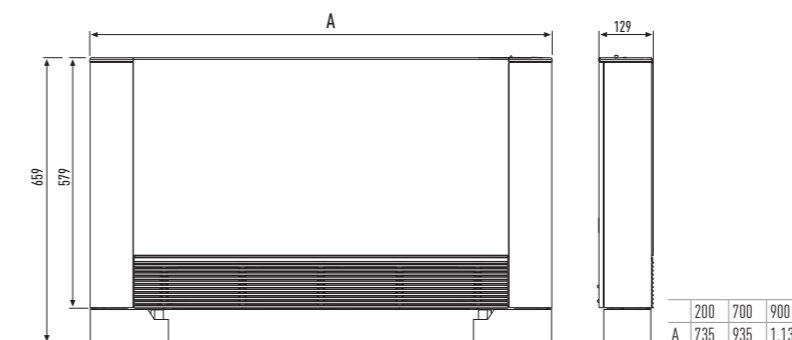

# SANITARY TANKS

## A wide range of tanks adapted to every need

Panasonic offers best combination of Aquarea with DHW. Wide range of tanks to adapt to any specific need with high quality standards. The wide range is covered with 1 Tank with buffer tank, 2 Stainless Tanks with "A" Class and 5 Enamelled tanks from 150 to 400L.

## Aquarea Tank. DHW tank with buffer tank.

Designed for retrofit applications, the DHW 200L tank with a 80L buffer tank is particularly suitable for fast integration on an existing installation. Panasonic has developed a tank with 80L Buffer tank and 200L sanitary hot water cylinder. This tank includes a 3-way valve and an "A" Class pump. Easy to install, nice looking, high efficiency for DHW production and for heating.

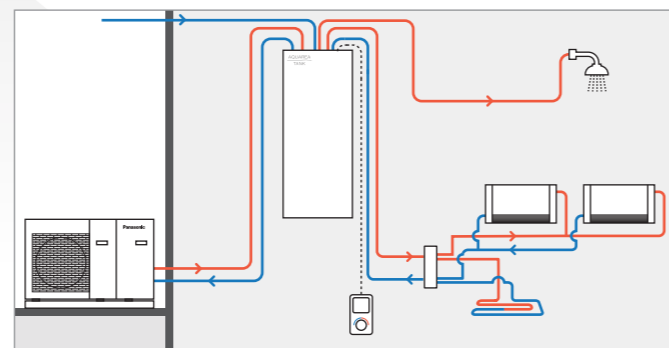



Aquarea Tank. Tanks and buffer tank in one!		PAW-TD20B8E3-NDS	
Water volume	L	185 (for DHW tank) / 80 (for buffer tank)	
Maximum water temperature	°C	100	
Dimension / Weight	H x W x D	1.810 x 600 x 632 / 150	
Electric heater	kW	3	
Power supply	V	230 - 2p	
Material inside tank		Stainless steel	
Exchange surface	m²	2,3	
Energy loss at 65°C¹	kWh/24h	1,3	
A class pump	Number of speed	Stepless (800-4250 rpm)	
	Pressure drop (Min / Max)	5 / 6	
	Input power (Min / Max)	3 / 45	
3 Way valve included		Yes	
Safety thermostat with contact for failure part of E-Heating		Yes	
Location of the electrical heater		Mid	
Electrical backup heater on the buffer tank		Optional	



## Stainless Steel Tank





The best heat pump in market needs to be complemented with best efficiency tank. Panasonic "A" Class Stainless Tank consist in 2 capacities 200 and 300L. These 2 models are anode free does not require any maintenance.

Tanks	Stainless Steel Tank		
	PAW-TD20C1E5	PAW-TD30C1E5	
Model			
Water volume	L	192	
Maximum water temperature	°C	75	
Dimensions	Height / Diameter	mm	1.265 / 595
Weight / filled with water	kg	53 / —	
Electric heater	kW	1,5	
Power supply	V	230	
Material inside tank		Stainless steel	
Exchange surface	m²	1,8	
Energy loss at 65°C¹	kWh/24h	0,99	
3 Way valve accessory PAW-3WVVLV-SI or CZ-NV1		Optional	
20m temperature sensor cable included		Yes	
Heat up time	Valuation	★★★★	
Energy losses	Valuation	★★★★	
Energy Efficiency Class		A	
Warranty		2 years	
Maintenance required		No	

1) Insulated tested under EN12897. \* Includes proportional control thermostat.

## Enamelled Tank

With our enamelled tanks wide range, we can satisfy any size needs. Consisting on 4 different size: 150, 200, 300 and 400L. The 300L is also available in with 2 coils version.

Tanks	Enamelled Tank				Enamelled 2 coils Tank (for bivalent Solar + HP)
	PAW-TG15C1EZ**	PAW-TG20C1E3STD-1	PAW-TG30C1E3STD-1	PAW-TG40C1E3STD-1	PAW-TG30C2E3STD-1
Model					
Water volume	L	150	185	285	284
Maximum water temperature	°C	95	95	95	95
Dimensions	Height / Diameter	mm	500 x 1.345	1.507 / 580	1.565 / 680
Weight / filled with water	kg	97 / 282	140 / 425	171 / 567	134 / 418
Electric heater	kW	3	3	3	3
Power supply	V	230	230	230	230
Material inside tank		Steel enamelled	Enamelled	Enamelled	Enamelled
Exchange surface	m²	1,4	2,0	2,5	6,1
Energy loss at 65°C¹	kWh/24h	1,6	1,6	2,1	1,7
3 Way valve accessory PAW-3WVVLV-SI or CZ-NV1		Optional	Optional	Optional	Optional
20m temperature sensor cable included		Yes	Yes	Yes	Yes
Heat up time	Valuation	★★★★	★★★★	★★★★	★★★★
Energy losses	Valuation	★★★★	★★★★	★★★★	★★★★
Energy Efficiency Class		C	C	B	B
Warranty		2 years	2 years	2 years	2 years
Maintenance required		Yearly	Yearly	Yearly	Yearly

1) Insulated tested under EN12897. \* Includes proportional control thermostat. \*\* Tentative image.

# AQUAREA DHW

# AQUAREA DHW

### DHW tank with built-in Heat Pump

The Heat Pump is one of the most energy efficient and cost effective methods of water heating. The pump is mounted on the storage tank and draws energy from the ambient air, using that extra energy source to heat the water up to 55°C.

### All new DHW HP will be delivered with a plug, because:

1. IP protection
2. Pull forces
3. No junction box – we want to avoid to have disassembling though installation
4. Bench mark analysis

### Wall mounted Aquarea DHW. Mid Capacity: 80/100/120L

Designed for maximum energy savings, Aquarea DHW's medium tank volume has been designed as a perfect replacement for the electric water heater. The conventional medium tank volume has been boosted with a heat pump generator, which delivers superior energy performance. The air-to-water heat pump design with air ducts enables the selection of inlet and outlet points for the air, which allows it to be used in various parts of the home (kitchen, bathroom, sunrooms, etc.).



### Aquarea DHW Advantages

- High-technology rotational compressor ensures higher energy efficiency and a higher coefficient of performance, which means major energy savings – up to 75%.
- Wrapped around the inside of the outer cover of the tank, it prevents the build-up of limescale, extends the useful life of the equipment and improves safety.
- The dimensions and heating capability of a medium volume Aquarea DHW tank can easily replace an existing electric water heater. Its small size allows it to be installed in spaces where previously a conventional electric water heater would be installed.
- Impressive tank protection is provided through the use of superior super-clean enamel and a large magnesium element. These ensure durability even in the harshest operating conditions, without harmful additives in the water.

### Floor standing at -7°C Aquarea DHW. High capacity: 200/295L

The DHW is ready to achieve levels of high efficiency even at temperatures as low as -7°C. With this range it is possible to connect an additional heat source, such as solar energy. In PAW-DHWM300AE, the heat pump cools and de-humidifies the air pumped either from outdoors or from within the building. By choosing the point of air capture and exhaust, you can ventilate and de-humidify some rooms, while extracting the cooled air either into the environment or into another room that you wish to cool.

### Floor standing at -7°C Aquarea DHW. High capacity: 200/295L

#### Technical focus

- Energy efficiency A class
- 119,1 % Energy efficiency  $\eta_{wh}^1$
- 1.204,2kWh AEC annual electricity consumption<sup>1</sup>
- 6,57kWh Daily electricity consumption  $Q_{elec}^2$
- 55°C Thermostat temperature settings
- 0 Value of smart

1) EU Regulation 812/2013 ; EN 16147:2010. 2) EN 16147:2010.

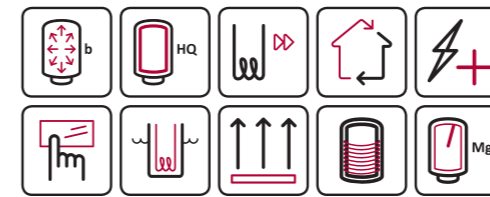

### Wall mounted Aquarea DHW. Mid Capacity: 80/100/120L

#### Technical focus

- Capacity: 80, 100 and 120L
- Vertical wall mounting
- Operating range between -7°C to +35°C
- LCD touch screen display

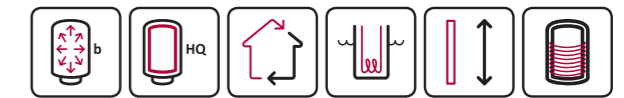

Model Reference	Floor standing at -7°C*			Wall mounted			
	PAW-DHWM200A	PAW-DHWM300A	PAW-DHWM300AE	PAW-DHWM80ZNT	PAW-DHWM100ZNT	PAW-DHWM120ZNT	
Volume	L	208	295	276	80	100	120
<b>Dimensions of Connections</b>							
Height / with air ducts	mm	1.540 x 670 x 690	1.960 x 670 x 690	1.960 x 670 x 690	1.197 x 506 x 533	1.342 x 506 x 533	1.497 x 506 x 533
Connections to the water supply network		G1	G1	G1	G 1/2	G 1/2	G 1/2
Dimensions of air ducts	mm / m	Ø160 / –	Ø160 / –	Ø160 / –	Ø125 (150 x 70) / 10	Ø125 (150 x 70) / 10	Ø125 (150 x 70) / 10
Net weight / with water	kg	149 / 365	164 / 459	207 / 480	58 / 138	62 / 162	68 / 188
<b>Heat Pump</b>							
Nominal electrical power	W	490	490	490	250	250	250
Reference tapping cycle	L	XL	XL	XL	M	M	M
Energy consumption by chosen cycle A7 / W10-55 <sup>1</sup>	kWh	4,05	5,77	5,96	2,45	2,35	2,51
Energy consumption by chosen cycle A15 / W10-55 <sup>2</sup>	kWh	3,95	5,65	5,75	2,04	2,05	2,08
COP DHW (A7 / W10-55) EN 16147 <sup>1</sup>		3,00	3,33	3,30	2,65	2,63	2,61
COP DHW (A15 / W10-55) EN 16147 <sup>2</sup>		3,07	3,39	3,38	3,10	3,10	3,10
Energy Efficiency Class		<b>A</b>	<b>A</b>	<b>A</b>	<b>A</b>	<b>A</b>	<b>A</b>
Standby power input according to EN16147	W	28	18	20	19	20	27
Sound power / Sound Pressure on 1m	dB / dB(A)	– / 58	– / 58	– / 58	51,0 / 39,5	51,0 / 39,5	51,0 / 39,5
Refrigerant		R134a	R134a	R134a	R134a	R134a	R134a
Quantity of refrigerant	g	1.100	1.100	1.100	540	540	540
Operating range - air temperature	°C	-7 / +35	-7 / +35	-7 / +35	-7 / +35	-7 / +35	-7 / +35
Nominal air flow rate (Maximum)	m³/min	7,5	7,5	7,5	1,7 - 3,8	1,7 - 3,8	1,7 - 3,8
Maximum pressure drop (volumetric flow rate at 5,5m³/min (60%))	Pa	100	100	100	–	–	–
Pressure drop by 2,5m³/min (60%/80%) (Maximum) <sup>3</sup>	Pa	–	–	–	70 (90)	70 (90)	70 (90)
<b>Storage Tank</b>							
Enamelled steel tank / Protective magnesium anode		+ / +	+ / +	+ / +	+ / +	+ / +	+ / +
Average insulation thickness	mm	–	–	–	40 - 85	40 - 85	40 - 85
External source exchanger (m² surface / connection)		–	–	2,7 / G1	–	–	–
<b>Electrical Specifications</b>							
Maximum power consumption without heater / with heater	W	490 / 2.490	490 / 2.490	490 / 2.490	– / 2.350	– / 2.350	– / 2.350
Number of electrical heaters x power	W	2 x 1.000	2 x 1.000	2 x 1.000	2 x 1.000	2 x 1.000	2 x 1.000
Voltage / Frequency	V / Hz	230 / 50	230 / 50	230 / 50	230 / 50	230 / 50	230 / 50
Electric protection	A	16	16	16	16	16	16
Moisture protection		IP24	IP24	IP24	IP24	IP24	IP24
Working pressure (Storage tank / Heat Exchanger)	Mpa (bar)	0,6 (6) / 0,9 (9)	0,6 (6) / 0,9 (9)	1,0 (10)	1,0 (10)	1,0 (10)	1,0 (10)
<b>Maximum Temperature</b>							
Heating with heat pump Min / Max	°C	55 / 65	55 / 65	55 / 65	55 / –	55 / –	55 / –
Heating with electrical heater	°C	75	75	75	75	75	75
<b>Refrigerant information</b>							
Refrigerant (R134a) <sup>4</sup>	kg / TCO: Eq.	1,100 / 1,573	1,100 / 1,573	1,100 / 1,573	0,540 / 0,772	0,540 / 0,772	0,540 / 0,772

1) Heating of sanitary water up to 55°C with inlet air temperature at 7°C, humidity at 89% and inlet water temperature at 10°C. According to EN16147. 2) Heating of sanitary water up to 55°C with inlet air temperature at 15°C, humidity at 74% and inlet water temperature at 10°C. According to EN16147. 3) Normal fan speed 60%, higher fan speed - special setting on 80%. 4) Aquarea DHW units are hermetically sealed.

\* When connected as pressurised, use of safety valve is mandatory.



5 years warranty for the tank himself, all other parts have two years warranty

# ACCESSORIES & CONTROL

## Optional PCB's for additional functions

- CZ-NS2P**  
PCB for solar connection kit for Mono-bloc systems.
- CZ-NS3P**  
PCB for solar connection kit for Mono-bloc systems 6kW and 9kW.
- CZ-NS4P**  
PCB for advanced functions in H Generation.

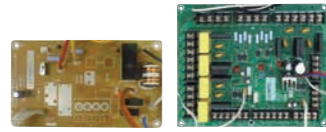

## Deice accessories

- CZ-NE1P**  
Base pan heater (for all old Bi-bloc and Mono-bloc, not for the 3 and 5kW).
- CZ-NE2P**  
Base pan heater (for 3kW and 5kW).
- CZ-NE3P**  
Base pan heater (for all new F Generation products: F3, F6, F9).



## Accessories for All in One

- PAW-ADC-PREKIT-1**  
Flexible pipings and wall mounting plate for All in One H Generation.
- PAW-ADC-PREKIT**  
Flexible pipings and wall mounting plate for All in One G Generation.
- PAW-ADC-CV150**  
Decorative magnetic side cover.



## Accessories for Aquarea Air

- PAW-AAIR-LEGS-1**  
Kits of 2 legs to support the Aquarea Air on the floor and to protect the water pipings.

## Accessories for Aquarea DHW

- PAW-DHWE2C**  
2kW optional electrical heater for floor standing.
- PAW-DHWE3C**  
3kW optional electrical heater for floor standing.

## Sanitary tank accessories

- PAW-TS1**  
Tank sensor with 6m cable length.
- PAW-TS2**  
Tank sensor with 20m cable length.
- PAW-TS4**  
Tank sensor with 6m cable length and only 6mm diameter.
- CZ-TK1**  
Temperature sensor kit for third party tank (with copper pocket and 6m length sensor cable).



## Special outdoor supports

- PAW-WTRAY**  
Tray for condenser water compatible with base ground support.
- PAW-GRDSTD40**  
Outdoor elevation platform.
- PAW-GRDBSE20**  
Outdoor base ground support for noise and vibration absorption (600 x 95 x 130mm, 500kg).



## Hydraulic accessories

- PAW-2PMP2ZONE**  
2 zone kit, hydraulic switch, manifold, 2 A-class pumps, 1 mixture valve.
- PAW-A2W-2ZONECYR**  
2 zone kit box cover.
- PAW-A2W-2ZONEKIT**  
2 zone kit.
- PAW-FILTER\***  
2 check valves + filter with 1" (no needed for H Generation).
- PAW-FILTER-ONLY\***  
Filter with 1" (no needed for H Generation).
- PAW-A2WFILTERFLOW\***  
Filter and water flow meter (no needed for H Generation).
- PAW-BTANK50L**  
Buffer tank 50L
- CZ-NV1**  
3 way valve ready for All in One H Generation (optional in internal space).
- PAW-3WYVLV-SI**  
3 way valve.



## Aquarea Manager Kits\*

- PAW-HPM12ZONE-U**  
HPM with room sensor and setpoint adaption for Bi-bloc + sensors.
- PAW-HPM12ZONE-M**  
HPM with room sensor and setpoint adaption for Mono-bloc + sensors.
- PAW-HPM12ZONE-UF**  
HPM with room sensor and setpoint adaption for F Generation Bi-bloc and Mono-bloc.
- PAW-HPM12ZONE-MF**  
HPM with room sensor and setpoint adaption for F Generation Bi-bloc and Mono-bloc.
- PAW-HPM12ZONE-LCD-U**  
HPM with LCD wireless room thermostat for Bi-bloc + sensors.
- PAW-HPM12ZONE-LCD-M**  
HPM with LCD wireless room thermostat for Mono-bloc + sensors.
- PAW-HPM12ZONE-LCD-UF**  
HPM with LCD wireless room thermostat for F Generation Bi-bloc and Mono-bloc.
- PAW-HPM12ZONE-LCD-M**  
HPM with LCD wireless room thermostat for F Generation Bi-bloc and Mono-bloc.

\* Not compatible with H Generation.

## Aquarea Manager accessories\*

- PAW-HPM1**  
Aquarea Manager with LCD.
- PAW-HPM2**  
Aquarea Manager without LCD.
- PAW-HPMINT-U**  
Interface to connect Aquarea Manager to Heat pump Aquarea Bi-bloc (HPM can control all parameters from HP).
- PAW-HPMINT-M**  
Interface to connect Aquarea Manager to Heat pump Aquarea Mono-bloc (HPM can control all parameters from HP).
- PAW-HPMINT-F**  
Interface to connect Aquarea Manager to Heat pump Aquarea Mono-bloc and Bi-bloc F type (HPM can control all parameters from HP).
- PAW-HPMB1**  
Buffer tank sensor.
- PAW-HPMDHW**  
Buffer tank sensor with well.
- PAW-HPMSOL1**  
Buffer tank sensor solar (with higher temperature range).
- PAW-HPMAH1**  
Water flow pipe sensor for heating circuit.
- PAW-HPMR4**  
Room sensor + set point adaptation.
- PAW-HPMED**  
Touch screen.
- PAW-HPMLCD**  
LCD Display HPM Manager.
- PAW-LANCABLE**  
Network cable.
- PAW-A2W SWITCH**  
Network switch.
- PAW-DEWPOINTSENSOR**  
Dew point sensor.
- PAW-HPMUH**  
Outdoor temperature sensor.



\* Not compatible with H Generation.

## Room thermostats

- PAW-A2W-RTWIRED**  
Wired LCD room thermostat with weekly timer.
- PAW-A2W-RTWIRELESS**  
Wireless LCD room thermostat with weekly timer.



## Controller\*

- PAW-A2W-BIV**  
Bivalent controller.



\* Not compatible with H Generation.

## Connectivity solutions

- CZ-TAW1**  
Aquarea Smart Cloud, H Generation Internet control through Wifi or wired LAN.
- PAW-AW-KNX-H**  
KNX interface for H Generation.
- PAW-AW-MBS-H**  
Modbus interface for H Generation.
- PAW-AW-KNX-1i\***  
KNX interface.
- PAW-AW-MBS-1\***  
Modbus interface.
- PA-AW-WIFI-1TE\***  
IntesisHome interface with temperature sensor accessory.



\* Not compatible with H Generation.

## H Generation sensors

- PAW-A2W-TS0D**  
Outdoor ambient sensor.
- PAW-A2W-TSRT**  
Zone room sensor.
- PAW-A2W-TSBU**  
Buffer tank sensor.
- PAW-A2W-TSHC**  
Zone water sensor.
- PAW-A2W-TSSO**  
Solar sensor.



## H Generation tools

- PAW-A2WLOGGER**  
Data Logger. With this tool we can log data during a long period.
- PAW-A2WCHECKER**  
Service checker. With this tool we will have a life monitoring at our PC.

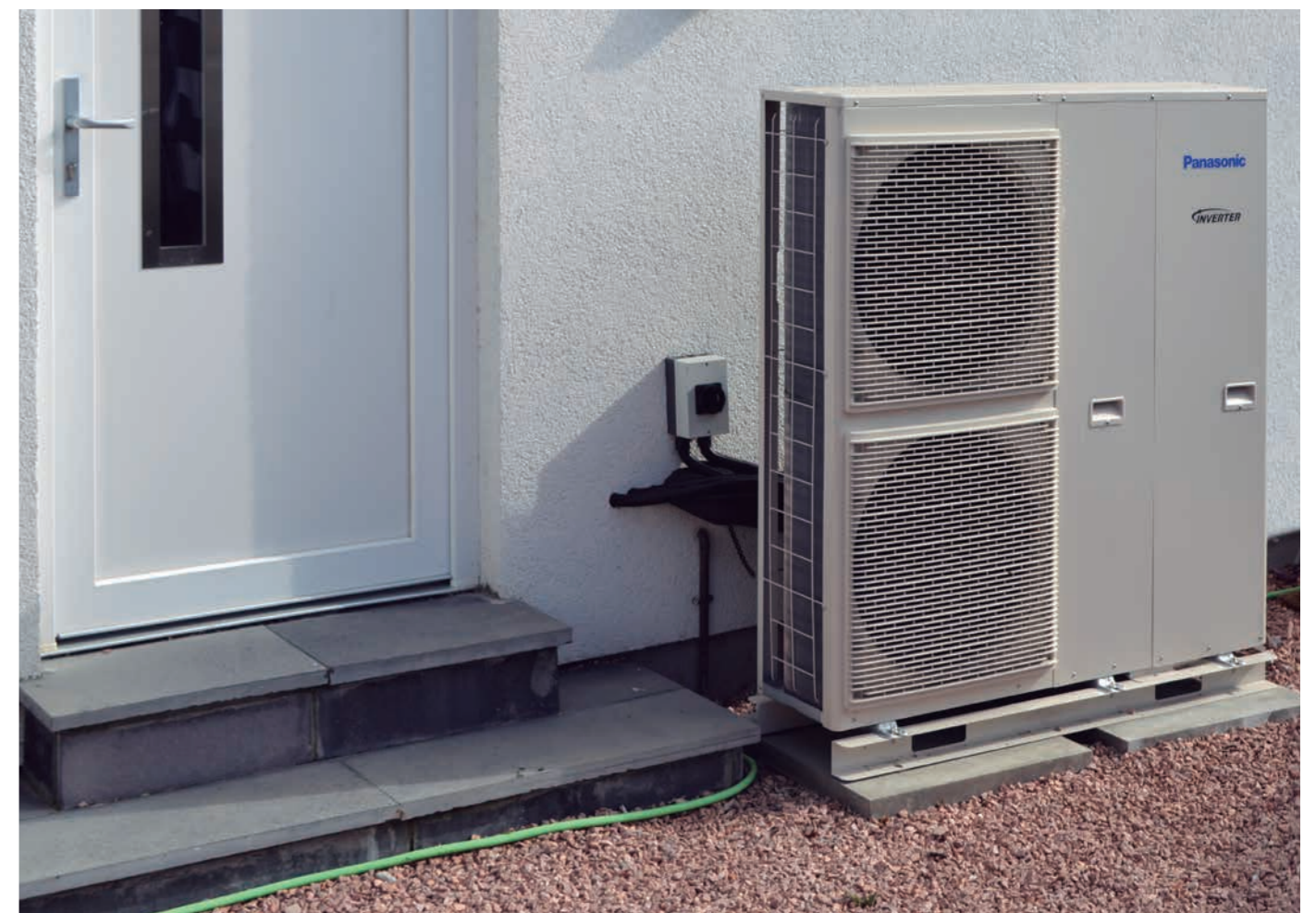

# PANASONIC'S AQUAREA OFFERS THE BEST FOR YOU AND YOUR HOME

Panasonic will supply the energy label and a product fiche for all delivered products affected by these regulations, which sales partners, traders and contractors must use when labelling our products.

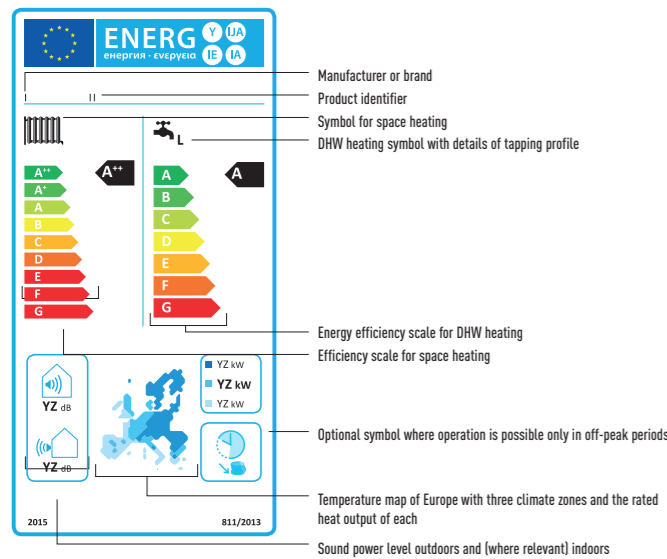

## Energy Label ErP

Fridges, dishwashers, washing machines, ovens – it all started with white goods in the 1990s. Today, other energy-consuming appliances also carry the European ErP energy efficiency label, such as TV sets, lighting and – since September 2014 – even vacuum cleaners. Since 2013 the regulations already apply to air conditioners and pumps. As of September 2015, it will also apply to room heaters, water heaters and storage water heaters. “ErP” stands for Energy related Products. Now, minimum energy efficiency requirements for energy efficient solutions (the Ecodesign Directive) are also specified for manufacturers of system and combi boilers, water heaters and DHW cylinders. This directive, valid throughout the European Union, and the label associated with it are intended to assist consumers in their purchasing decisions and to help reduce private energy demand, as well as combat climate change.

## Panasonic helps you to calculate the system label

From 26th September 2015, installers can be assured that all products manufactured after this date will be sold with the required ErP labels which will aid installers with their paperwork. While it is the manufacturer's responsibility to issue their products with the required labels, the installers will need to calculate and issue an efficiency label for the entire heating system. Whether installing a new heating system or installing new boilers, controls or renewables into an existing system, it is, and will continue to be, the installer's responsibility to calculate and issue efficiency labels. Calculators which assist installers with this process are available on [www.panasonicproclub.com](http://www.panasonicproclub.com).

## Information on the energy label

The rating system for heating Heat Pumps classifies them into nine efficiency categories. The best energy efficiency category is A++. Category G identifies appliances with significantly poorer values. The ErP label for system boilers shows its efficiency category on a scale from A++ to G (to D for Heat Pumps, from A to G for hot water cylinders). In August 2019, a more rigorous scale will be introduced from A+++ to D, and from A+ to G for hot water cylinders.

Panasonic helps you to calculate the system label [www.panasonicproclub.com](http://www.panasonicproclub.com) or connect simply with your smartphone to the PRO Club using this QR



**PRO Club**



## A 125m<sup>2</sup> house in Reims

The example below shows a typical 3 bedroom French home and highlights the potential savings that can be achieved with Panasonic's Aquarea heat pump\*.

\* Calculations were carried using Panasonic's Aquarea Designer software, available from the PRO Club website ([www.panasonicproclub.com](http://www.panasonicproclub.com)).

Service hot water	
Type of service	Hot water with heat pump
Tank volume	300 Litre
Average daily need	200 Litre
Cold water inlet temperature	10°C
Target tank temperature	50°C
Exchange loss	5K
Electrical auxiliary heating necessary	No

Used Panasonic heat pump	
Description	T-CAP 12kW
Sanitary tank	Stainless steel 300L
Heat pump type	Air / Water
Capacity / consumption at 2°C (heating water at 35°C)	Heat: 11,7kW, Electric: 3,4kW
Recommended flow-through of air	80,0m <sup>3</sup> /min
Maximum flow temperature	55°C
Mode of operation	Monovalent
Design	-5,0°C
Number of heat pumps used	1
Wattage of fan (included in heat pump performance data: yes)	60W
Power consumption of heat circulation pump(s)	180W

Building data	
Address	Reims (French)
Building area	125m <sup>2</sup>
Standard heating requirement	11,3kW
Internal gains	5,625kWh/year
Solar gains (windows)	4,500kWh/year
Indoor design temperature	20°C
Outdoor temperature limit for heating "ON"	15°C
Heat distribution	Underfloor heating by 100 % Radiator heating by -- % Wall heating by -- %
Maximum flow water temperature	55°C
Maximum return water temperature	50°C
Solar collector area	-- m <sup>2</sup>

Rate data	
Description	French (Panasonic)
Shut off times total	0,0 h/day
Weekends with shut off times	Yes
Daytime rate of heat pump	Time for daytime rate 5-19 o'clock 14,0 pence/kWh
Nighttime rate of heat pump	Time for nighttime rate 19-5 o'clock 14,0 pence/kWh
Heat circulation pump(s)	Like heat pump: yes -- pence/kWh
Heating element for monoenergetic operation	Like heat pump: yes -- pence/kWh
Heating element for post heating of hot water	Like heat pump: yes -- pence/kWh

Climatic data	
Climatic location	Reims (FR)
Monthly average temperatures in °C	Jan 3,4 Apr 8,0 Jul 16,0 Oct 10,4 Feb 3,6 May 11,2 Aug 15,9 Nov 6,7 Mar 5,7 Jun 14,1 Sep 13,7 Dec 4,6

## Calculation results

### Monthly heat consumption in kWh

Annual energy costs		Caused by heat consumers	
<b>Caused by heat producers</b>			
Heat pump	1.600 €	Space heating	1.220 €
Hot water heating rod	0 €	Service hot water	225 €
		Heat circulation pump(s)	155 €
		<b>Total</b>	<b>1.600 €</b>

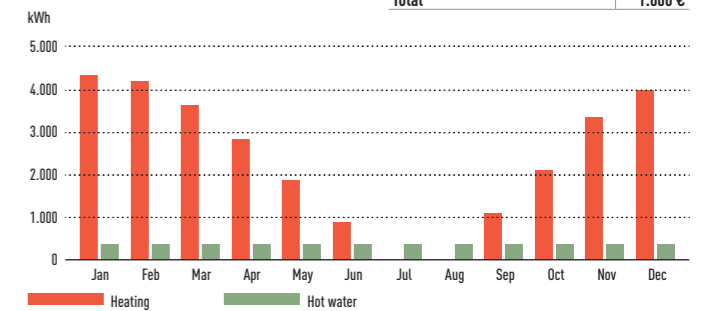

## Aquarea energy coverage

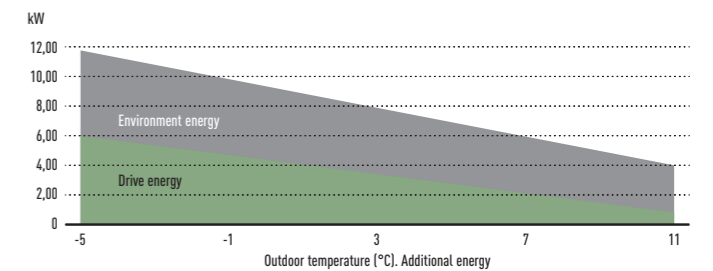

## Comparison of running costs

Operational costs				
Type of heating	Price in pence /kWh	Efficiency (%)	Additional costs in €/year	Total costs in €/year
Heat pump	-	-	0	1.600
Oil	6,5	85	0	3.050
Gas	4,0	90	0	1.868
Wood heating	5,0	80	0	2.539
Electric night storage heater	12,0	100	0	4.455
Electric heating element	14,0	100	0	5.197

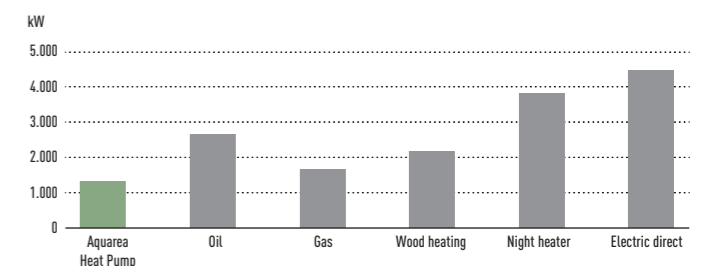

## Comparison of CO<sub>2</sub> emissions

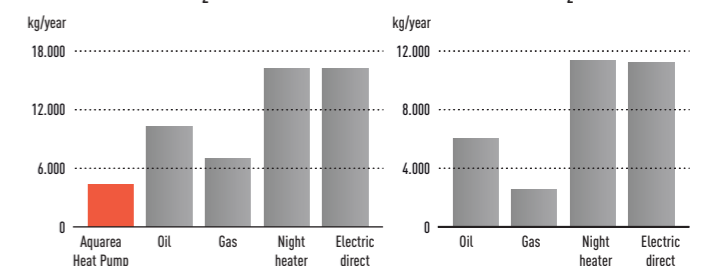

## Comparison of CO<sub>2</sub> savings

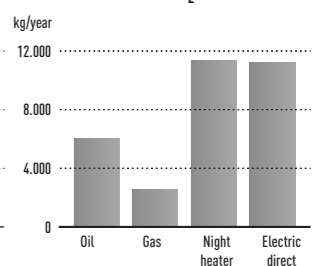





# HEATING & COOLING CAPACITY TABLES

Based on outlet temperature and outside temperature

## Heating capacity table

Aquarea All in One H Generation T-CAP Bi-bloc Three Phase. Heating and Cooling

WH-UX09HE8																		
Tamb	HC	IP	COP	HC	IP	COP	HC	IP	COP	HC	IP	COP	HC	IP	COP	HC	IP	COP
LWC	30	30	30	35	35	35	40	40	40	45	45	45	50	50	50	55	55	55
-15	9,00	3,24	2,78	9,00	3,51	2,56	9,00	3,91	2,30	9,00	4,30	2,09	9,00	4,73	1,90	9,00	5,16	1,74
-7	9,00	2,71	3,32	9,00	3,16	2,85	9,00	3,62	2,49	9,00	4,07	2,21	9,00	4,27	2,11	9,00	4,46	2,02
2	9,00	2,36	3,81	9,00	2,51	3,59	9,00	2,78	3,24	9,00	3,05	2,95	9,00	3,56	2,53	9,00	4,07	2,21
7	9,00	1,64	5,49	9,00	1,86	4,84	9,00	2,16	4,17	9,00	2,46	3,66	9,00	2,76	3,26	9,00	3,06	2,94
25	13,60	1,50	9,07	13,60	1,71	7,95	13,20	1,93	6,84	12,80	2,14	5,98	12,00	2,41	4,98	11,20	2,67	4,19

WH-UX12HE8																		
Tamb	HC	IP	COP	HC	IP	COP	HC	IP	COP	HC	IP	COP	HC	IP	COP	HC	IP	COP
LWC	30	30	30	35	35	35	40	40	40	45	45	45	50	50	50	55	55	55
-15	12,00	4,75	2,53	12,00	4,96	2,42	12,00	5,41	2,22	12,00	5,86	2,05	11,80	6,24	1,89	11,60	6,62	1,75
-7	12,00	3,85	3,12	12,00	4,41	2,72	12,00	4,98	2,41	12,00	5,54	2,17	12,00	5,90	2,03	12,00	6,26	1,92
2	12,00	3,19	3,76	12,00	3,49	3,44	12,00	3,87	3,10	12,00	4,25	2,82	12,00	4,86	2,47	12,00	5,47	2,19
7	12,00	2,18	5,50	12,00	2,53	4,74	12,00	2,96	4,05	12,00	3,39	3,54	12,00	3,78	3,17	12,00	4,16	2,88
25	13,60	1,55	8,77	13,60	1,76	7,73	13,40	2,10	6,38	13,20	2,43	5,43	12,60	2,66	4,74	12,00	2,89	4,15

WH-UX16HE8																		
Tamb	HC	IP	COP	HC	IP	COP	HC	IP	COP	HC	IP	COP	HC	IP	COP	HC	IP	COP
LWC	30	30	30	35	35	35	40	40	40	45	45	45	50	50	50	55	55	55
-15	16,00	6,30	2,54	16,00	6,89	2,32	16,00	7,45	2,15	16,00	8,10	1,98	16,00	8,48	1,89	15,20	8,96	1,70
-7	16,00	5,85	2,74	16,00	6,42	2,49	16,00	7,00	2,29	16,00	7,57	2,11	16,00	8,10	1,98	16,00	8,62	1,86
2	16,00	4,67	3,43	16,00	5,21	3,07	16,00	5,74	2,79	16,00	6,31	2,54	16,00	6,90	2,32	16,00	7,50	2,13
7	16,00	3,35	4,78	16,00	3,74	4,28	16,00	4,30	3,72	16,00	4,80	3,33	16,00	5,43	2,95	16,00	5,91	2,71
16	16,00	2,59	6,18	16,00	3,18	5,03	16,00	3,71	4,31	16,00	4,27	3,75	16,00	4,86	3,29	16,00	5,22	3,07
25	16,00	2,02	7,92	16,00	2,58	6,20	16,00	2,91	5,50	16,00	3,36	4,76	16,00	3,74	4,28	16,00	4,00	4,00

## Cooling capacity table

Aquarea All in One H Generation T-CAP Bi-bloc Three Phase. Heating and Cooling

WH-UX09HE8						
Tamb	CC	IP	EER	CC	IP	EER
LWC	7	7	7	18	18	18
18	7,00	1,36	5,15	—	—	—
25	7,65	1,91	4,01	—	—	—
35	7,00	2,21	3,17	—	—	—
43	6,25	2,66	2,35	—	—	—

WH-UX12HE8						
Tamb	CC	IP	EER	CC	IP	EER
LWC	7	7	7	18	18	18
18	7,50	1,41	5,32	—	—	—
25	8,90	2,16	4,12	—	—	—
35	10,00	3,56	2,81	—	—	—
43	8,00	3,01	2,66	—	—	—

WH-UX16HE8						
Tamb	CC	IP	EER	CC	IP	EER
LWC	7	7	7	18	18	18
18	8,50	1,70	5,00	10,00	1,70	5,88
25	14,00	4,00	3,50	14,00	2,94	4,76
35	12,20	4,76	2,56	12,20	3,50	3,49
43	7,10	3,31	2,15	9,80	3,31	2,96

Tamb: Ambient Temperature (°C). LWC: Leaving Water Condenser Temperature (°C). HC: Heating Capacity (kW). CC: Cooling Capacity (kW). IP: Power Input (kW)  
This data is measured by Panasonic in accordance with EN14511-2 standard. This data is for reference purpose only, and does not guarantee the performance.

## Heating capacity table

Aquarea High Performance Bi-bloc Single Phase / Three Phase. Heating and Cooling

WH-UD09FE8																		
Tamb	HC	IP	COP	HC	IP	COP	HC	IP	COP	HC	IP	COP	HC	IP	COP	HC	IP	COP
LWC	30	30	30	35	35	35	40	40	40	45	45	45	50	50	50	55	55	55
-15	8,65	3,06	2,83	8,30	3,21	2,59	7,95	3,41	2,33	7,60	3,61	2,11	7,15	3,71	1,93	6,70	3,81	1,76
-7	9,35	2,91	3,21	9,00	3,16	2,85	8,85	3,54	2,50	8,70	3,92	2,21	8,30	3,89	2,13	7,90	3,86	2,05
2	9,31	2,35	3,96	9,00	2,51	3,59	9,00	2,78	3,24	9,00	3,05	2,95	8,90	3,49	2,55	8,80	3,94	2,23
7	9,00	1,54	5,84	9,00	1,86	4,84	9,00	2,16	4,17	9,00	2,46	3,66	9,00	2,76	3,26	9,00	3,06	2,94
25	9,00	1,05	8,57	9,00	1,24	7,26	8,73	1,44	6,06	8,46	1,64	5,16	8,28	1,82	4,55	8,10	2,00	4,05

WH-UD12FE5 / WH-UD12FE8																		
Tamb	HC	IP	COP	HC	IP	COP	HC	IP	COP	HC	IP	COP	HC	IP	COP	HC	IP	COP
LWC	30	30	30	35	35	35	40	40	40	45	45	45	50	50	50	55	55	55
-15	9,30	3,46	2,69	8,90	3,62	2,46	8,50	3,79	2,24	8,10	3,95	2,05	7,50	4,05	1,85	7,00	4,16	1,68
-7	10,40	3,37	3,09	10,00	3,66	2,73	9,60	3,95	2,43	9,20	4,24	2,17	8,70	4,26	2,04	8,20	4,27	1,92
2	11,80	3,10	3,81	11,40	3,31	3,44	11,00	3,53	3,12	10,60	3,74	2,83	9,80	3,94	2,49	9,10	4,14	2,20
7	12,00	2,10	5,71	12,00	2,53	4,74	12,00	2,96	4,05	12,00	3,39	3,54	12,00	3,78	3,17	12,00	4,16	2,88
25	12,00	1,38	8,70	12,00	1,66	7,23	11,80	1,94	6,08	11,70	2,23	5,25	11,50	2,49	4,62	11,40	2,74	4,16

WH-UD16FE5 / WH-UD12FE8																		
Tamb	HC	IP	COP	HC	IP	COP	HC	IP	COP	HC	IP	COP	HC	IP	COP	HC	IP	COP
LWC	30	30	30	35	35	35	40	40	40	45	45	45	50	50	50	55	55	55
-15	10,60	4,09	2,59	10,30	4,38	2,35	10,00	4,67	2,14	9,70	4,96	1,96	8,80	4,94	1,78	7,90	4,91	1,61
-7	11,90	4,03	2,95	11,40	4,43	2,57	10,80	4,83	2,24	10,30	5,22	1,97	9,60	5,09	1,89	9,00	4,95	1,82
2	13,50	3,74	3,61	13,00	3,96	3,28	12,40	4,18	2,97	11,90	4,40	2,70	10,80	4,46	2,42	9,80	4,51	2,17
7	16,00	3,21	4,98	16,00	3,74	4,28	16,00	4,27	3,75	16,00	4,80	3,33	15,20	5,11	2,97	14,50	5,41	2,68
25	16,00	2,31	6,93	16,00	2,69	5,95	16,00	3,07	5,21	16,00	3,45	4,64	16,00	3,67	4,36	15,90	3,89	4,09

## Cooling capacity table

Aquarea High Performance Bi-bloc Single Phase / Three Phase. Heating and Cooling

WH-UD09FE8									WH-UD12FE5 / WH-UD12FE8									
Models	CC	IP	EER	CC	IP	EER	CC	IP	EER	CC	IP	EER	CC	IP	EER	CC	IP	EER
LWC	7	7	7	14	14	14	18	18	18	7	7	7	14	14	14	18	18	18
18	7,50	1,15	6,52	9,10	1,20	7,58	7,00	1,13	6,19	7,86	1,18	6,66	13,15	1,40	9,39	10,00	1,73	5,78
25	8,35	1,77	4,72	10,90	1,78	6,12	7,00	1,24	5,65	12,08	2,90	4,17	15,70	2,05	7,66	10,00	1,97	5,08
35	7,00	2,23	3,14	8,30	2,32	3,58	7,00	1,52	4,61	10,00	2,56	3,91	12,00	2,67	4,49	10,00	2,40	4,17
43	5,52	2,54	2,17	7,69	2,77	2,78	5,60	1,80	3,11	7,80	3,80	2,05	11,10	3,19	3,48	8,00	2,85	2,81

Tamb: Ambient Temperature (°C). LWC: Leaving Water Condenser Temperature (°C). HC: Heating Capacity (kW). CC: Cooling Capacity (kW). IP: Power Input (kW)  
This data is measured by Panasonic in accordance with EN14511-2 standard. This data is for reference purpose only, and does not guarantee the performance.

### Hydraulic Pump Performance of the F type Heat Pumps: A class pump F (5kW and 16kW)

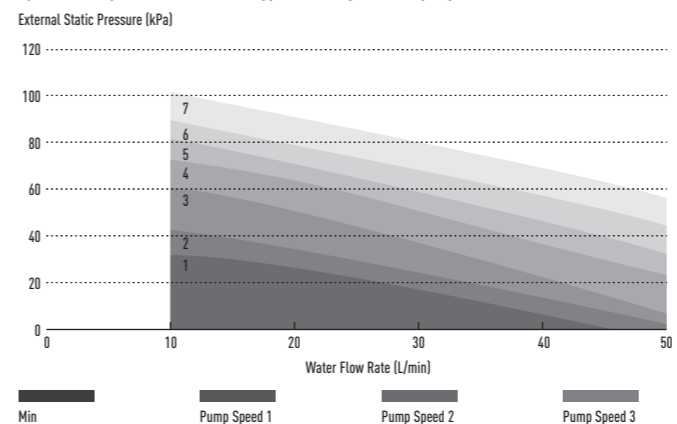

### Hydraulic Pump Performance of the F type Heat Pumps: A class pump F (5kW and 16kW)

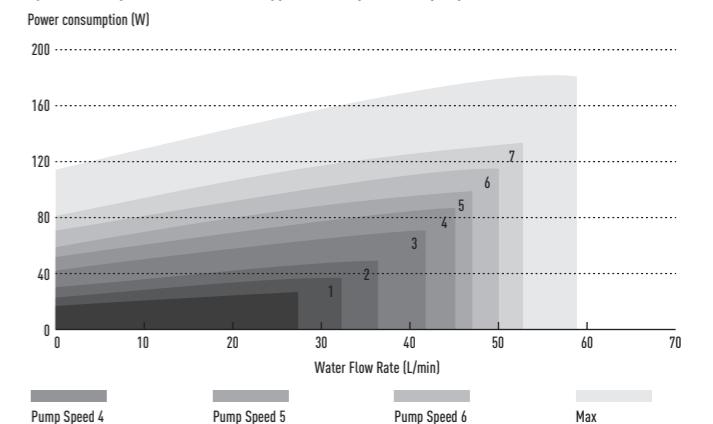

# HEATING & COOLING CAPACITY TABLES

Based on outlet temperature and outside temperature

## Heating capacity table

Aquarea T-CAP Bi-bloc Single Phase. Heating and Cooling  
WH-UX09FE5

Tamb	HC	IP	COP	HC	IP	COP	HC	IP	COP	HC	IP	COP	HC	IP	COP	HC	IP	COP
LWC	30	30	30	35	35	35	40	40	40	45	45	45	50	50	50	55	55	55
-15	9,00	3,24	2,78	9,00	3,51	2,56	9,00	3,91	2,30	9,00	4,30	2,09	9,00	4,73	1,90	9,00	5,16	1,74
-7	9,00	2,71	3,32	9,00	3,16	2,85	9,00	3,62	2,49	9,00	4,07	2,21	9,00	4,27	2,11	9,00	4,46	2,02
2	9,00	2,36	3,81	9,00	2,51	3,59	9,00	2,78	3,24	9,00	3,05	2,95	9,00	3,56	2,53	9,00	4,07	2,21
7	9,00	1,64	5,49	9,00	1,86	4,84	9,00	2,16	4,17	9,00	2,46	3,66	9,00	2,76	3,26	9,00	3,06	2,94
25	13,60	1,50	9,07	13,60	1,71	7,95	13,20	1,93	6,84	12,80	2,14	5,98	12,00	2,41	4,98	11,20	2,67	4,19

Tamb	HC	IP	COP	HC	IP	COP	HC	IP	COP	HC	IP	COP	HC	IP	COP	HC	IP	COP
LWC	30	30	30	35	35	35	40	40	40	45	45	45	50	50	50	55	55	55
-15	12,00	4,75	2,53	12,00	4,96	2,42	12,00	5,17	2,22	11,00	5,38	2,04	10,80	5,82	1,86	10,50	6,26	1,68
-7	12,00	3,85	3,12	12,00	4,41	2,72	12,00	4,98	2,41	12,00	5,54	2,17	12,00	5,90	2,03	12,00	6,26	1,92
2	12,00	3,19	3,76	12,00	3,49	3,44	12,00	3,87	3,10	12,00	4,25	2,82	12,00	4,86	2,47	12,00	5,47	2,19
7	12,00	2,18	5,50	12,00	2,53	4,74	12,00	2,96	4,05	12,00	3,39	3,54	12,00	3,78	3,17	12,00	4,16	2,88
25	13,60	1,55	8,77	13,60	1,76	7,73	13,40	2,10	6,38	13,20	2,43	5,43	12,60	2,66	4,74	12,00	2,89	4,15

## Cooling capacity table

Aquarea T-CAP Bi-bloc Single Phase. Heating and Cooling  
WH-UX09FE5

Tamb	CC	IP	EER	CC	IP	EER	CC	IP	EER
LWC	7	7	7	14	14	14	18	18	18
18	7,00	1,36	5,15	8,55	1,41	6,06	7,00	1,00	7,00
25	7,65	1,91	4,01	11,10	1,98	5,61	7,00	1,10	6,36
35	7,00	2,21	3,17	9,23	2,37	3,89	7,00	1,35	5,19
43	6,25	2,66	2,35	8,55	2,71	3,15	5,60	1,60	3,50

Tamb	CC	IP	EER	CC	IP	EER	CC	IP	EER
LWC	7	7	7	14	14	14	18	18	18
18	10,00	1,75	5,71	13,20	1,96	6,73	10,00	1,40	7,14
25	11,20	2,67	4,19	16,50	3,01	5,48	10,00	1,60	6,25
35	10,00	3,56	2,81	12,55	3,63	3,46	10,00	1,95	5,13
43	8,00	3,35	2,39	10,00	3,46	2,89	8,00	2,30	3,48

Tamb: Ambient Temperature (°C). LWC: Leaving Water Condenser Temperature (°C). HC: Heating Capacity (kW). CC: Cooling Capacity (kW). IP: Power Input (kW)  
This data is measured by Panasonic in accordance with EN14511-2 standard. This data is for reference purpose only, and does not guarantee the performance.

## Heating capacity table

Aquarea HT Bi-bloc Single Phase / Three Phase. Heating Only  
WH-UH09FE5

Tamb	HC	IP	COP	HC	IP	COP	HC	IP	COP	HC	IP	COP	HC	IP	COP	HC	IP	COP
LWC	30	30	30	35	35	35	40	40	40	45	45	45	50	50	50	55	55	55
-15	9,00	3,46	2,60	9,00	3,71	2,43	9,00	4,01	2,24	8,80	4,26	2,07	8,60	4,61	1,87	8,50	4,91	1,73
-7	9,00	3,06	2,94	9,00	3,29	2,74	9,00	3,56	2,53	8,90	3,83	2,32	8,90	4,11	2,17	8,90	4,46	2,00
2	9,00	2,43	3,70	9,00	2,61	3,45	9,00	2,91	3,09	9,00	3,21	2,80	9,00	3,55	2,54	9,00	3,88	2,32
7	9,00	1,82	4,95	9,00	1,94	4,64	9,00	2,21	4,07	9,00	2,46	3,66	9,00	2,76	3,26	9,00	3,06	2,94
16	9,00	1,46	6,16	9,00	1,56	5,77	9,00	1,81	4,97	8,90	2,02	4,41	8,80	2,31	3,81	8,60	2,52	3,41
25	12,00	1,66	7,23	12,00	1,76	6,82	12,00	2,01	5,97	11,80	2,14	5,05	10,60	2,46	4,31	10,20	2,66	3,83

Tamb	HC	IP	COP	HC	IP	COP	HC	IP	COP	HC	IP	COP	HC	IP	COP	HC	IP	COP
LWC	30	30	30	35	35	35	40	40	40	45	45	45	50	50	50	55	55	55
-15	12,00	5,16	2,33	12,00	5,53	2,17	11,00	5,51	2,00	10,60	5,53	1,92	10,30	5,63	1,83	9,70	5,76	1,68
-7	12,00	4,43	2,71	12,00	4,76	2,52	11,50	4,91	2,34	11,20	5,06	2,21	10,80	5,16	2,09	10,10	5,28	1,91
2	12,00	3,42	3,51	12,00	3,68	3,26	11,50	3,86	2,98	11,30	4,14	2,73	11,00	4,51	2,44	10,80	4,86	2,22
7	12,00	2,52	4,76	12,00	2,69	4,46	12,00	3,06	3,92	12,00	3,44	3,49	12,00	3,81	3,15	12,00	4,28	2,80
16	12,00	2,03	5,91	12,00	2,17	5,53	12,00	2,52	4,76	12,00	2,86	4,20	11,50	3,19	3,61	11,50	3,48	3,30
25	12,00	1,66	7,23	12,00	1,76	6,82	12,00	2,01	5,97	11,80	2,14	4,90	11,20	2,64	4,24	10,80	2,86	3,78

  

Tamb	HC	IP	COP	HC	IP	COP	HC	IP	COP	HC	IP	COP	HC	IP	COP	HC	IP	COP
LWC	30	30	30	35	35	35	40	40	40	45	45	45	50	50	50	55	55	55
-15	9,00	3,46	2,60	9,00	3,71	2,43	9,00	4,01	2,24	8,80	4,26	2,07	8,60	4,61	1,87	8,50	4,91	1,73
-7	9,00	3,06	2,94	9,00	3,29	2,74	9,00	3,56	2,53	8,90	3,83	2,32	8,90	4,11	2,17	8,90	4,46	2,00
2	9,00	2,43	3,70	9,00	2,61	3,45	9,00	2,91	3,09	9,00	3,21	2,80	9,00	3,55	2,54	9,00	3,88	2,32
7	9,00	1,82	4,95	9,00	1,94	4,64	9,00	2,21	4,07	9,00	2,46	3,66	9,00	2,76	3,26	9,00	3,06	2,94
16	9,00	1,46	6,16	9,00	1,56	5,77	9,00	1,81	4,97	8,90	2,02	4,41	8,80	2,31	3,81	8,60	2,52	3,41
25	12,00	1,66	7,23	12,00	1,76	6,82	12,00	2,01	5,97	11,80	2,14	4,90	11,20	2,64	4,24	10,80	2,86	3,78

  

Tamb	HC	IP	COP	HC	IP	COP	HC	IP	COP	HC	IP	COP	HC	IP	COP	HC	IP	COP
LWC	30	30	30	35	35	35	40	40	40	45	45	45	50	50	50	55	55	55
-15	12,00	5,16	2,33	12,00	5,53	2,17	11,00	5,51	2,00	10,60	5,53	1,92	10,30	5,63	1,83	9,70	5,76	1,68
-7	12,00	4,43	2,71	12,00	4,76	2,52	11,50	4,91	2,34	11,20	5,06	2,21	10,80	5,16	2,09	10,10	5,28	1,91
2	12,00	3,42	3,51	12,00	3,68	3,26	11,50	3,86	2,98	11,30	4,14	2,73	11,00	4,51	2,44	10,80	4,86	2,22
7	12,00	2,52	4,76	12,00	2,69	4,46	12,00	3,06	3,92	12,00	3,44	3,49	12,00	3,81	3,15	12,00	4,28	2,80
16	12,00	2,03	5,91	12,00	2,17	5,53	12,00	2,52	4,76	12,00	2,86	4,20	11,50	3,19	3,61	11,50	3,48	3,30
25	12,00	1,66	7,23	12,00	1,76	6,82	12,00	2,01	5,97	11,80	2,14	4,90	11,20	2,64	4,24	10,80	2,86	3,78

Hydraulic Pump Performance of the F type Heat Pumps: A class pump F (5kW and 16kW)

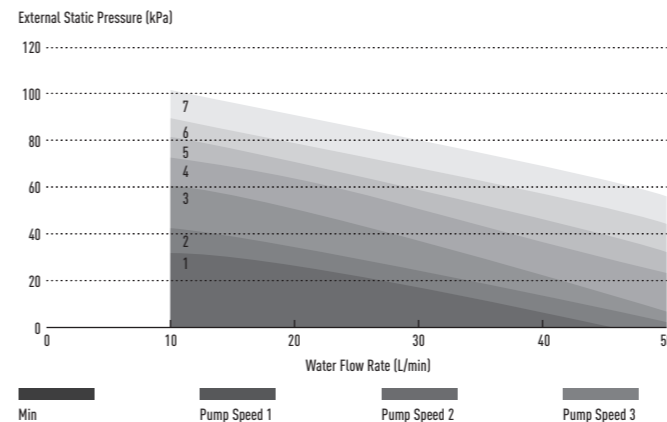

Hydraulic Pump Performance of the F type Heat Pumps: A class pump F (5kW and 16kW)

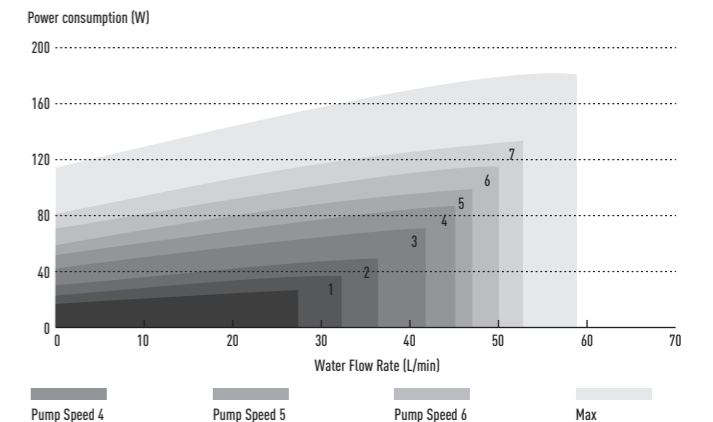

# HEATING & COOLING CAPACITY TABLES

Based on outlet temperature and outside temperature

## Heating capacity table

Aquarea G Generation High Performance Mono-bloc Single Phase. Heating and Cooling - MDC

WH-MDC05F3E5																		
Tamb	HC	IP	COP	HC	IP	COP	HC	IP	COP	HC	IP	COP	HC	IP	COP	HC	IP	COP
LWC	30	30	30	35	35	35	40	40	40	45	45	45	50	50	50	55	55	55
-15	5,00	1,82	2,75	5,00	1,95	2,56	5,00	2,20	2,27	5,00	2,45	2,04	5,00	1,68	2,99	5,00	2,90	1,72
-7	4,50	1,44	3,13	4,50	1,51	2,98	4,50	1,64	2,74	4,50	1,78	2,53	4,40	1,94	2,27	4,30	2,10	2,05
2	4,80	1,22	3,93	4,80	1,28	3,75	4,65	1,40	3,32	4,50	1,52	2,96	4,25	1,62	2,62	4,00	1,72	2,33
7	5,00	0,91	5,49	5,00	0,98	5,10	5,00	1,13	4,42	5,00	1,26	3,97	5,00	1,44	3,47	5,00	1,63	3,07
25	5,00	0,67	7,46	5,00	0,71	7,04	5,00	0,78	6,41	5,00	0,86	5,81	5,00	0,98	5,10	5,00	1,10	4,55
WH-MDC06G3E5																		
Tamb	HC	IP	COP	HC	IP	COP	HC	IP	COP	HC	IP	COP	HC	IP	COP	HC	IP	COP
LWC	30	30	30	35	35	35	40	40	40	45	45	45	50	50	50	55	55	55
-15	6,15	2,50	2,46	5,90	2,66	2,22	5,65	2,82	2,00	5,40	2,98	1,81	5,20	3,15	1,65	5,00	3,32	1,51
-7	5,18	1,68	3,08	5,15	1,92	2,68	5,13	2,17	2,36	5,10	2,41	2,12	5,45	2,81	1,94	5,80	3,20	1,81
2	5,00	1,23	4,07	5,00	1,45	3,45	5,00	1,68	2,98	5,00	1,90	2,63	5,00	2,19	2,28	5,00	2,48	2,02
7	6,00	1,13	5,31	6,00	1,35	4,44	6,00	1,58	3,80	6,00	1,80	3,33	6,00	2,09	2,87	6,00	2,38	2,52
25	7,30	0,78	9,36	7,10	0,93	7,63	6,90	1,09	6,33	6,70	1,24	5,40	6,50	1,41	4,61	6,30	1,58	3,99
WH-MDC09G3E5																		
Tamb	HC	IP	COP	HC	IP	COP	HC	IP	COP	HC	IP	COP	HC	IP	COP	HC	IP	COP
LWC	30	30	30	35	35	35	40	40	40	45	45	45	50	50	50	55	55	55
-15	7,90	3,62	2,19	7,60	3,77	2,02	7,30	3,93	1,86	7,00	4,08	1,72	6,45	4,06	1,59	5,90	4,03	1,46
-7	7,80	3,38	2,31	7,70	3,63	2,12	7,60	3,88	1,96	7,50	4,13	1,82	7,55	4,59	1,64	7,60	5,05	1,50
2	7,00	2,01	3,48	7,45	2,37	3,14	7,00	2,60	2,69	7,00	2,89	2,42	7,00	3,37	2,08	7,00	3,85	1,82
7	9,00	1,87	4,81	9,00	2,17	4,16	9,00	2,48	3,63	9,00	2,78	3,24	8,95	3,31	2,70	8,90	3,84	2,32
25	9,00	0,99	9,09	9,00	1,31	6,87	9,00	1,63	5,52	9,00	1,95	4,62	9,00	2,20	4,09	9,00	2,45	3,67
WH-MDC12G6E5																		
Tamb	HC	IP	COP	HC	IP	COP	HC	IP	COP	HC	IP	COP	HC	IP	COP	HC	IP	COP
LWC	30	30	30	35	35	35	40	40	40	45	45	45	50	50	50	55	55	55
-15	9,30	3,46	2,69	8,90	3,62	2,46	8,50	3,79	2,24	8,10	3,95	2,05	—	—	—	7,00	4,10	1,71
-7	10,40	3,37	3,09	10,00	3,66	2,73	9,60	3,95	2,43	9,20	4,24	2,17	—	—	—	8,20	4,21	1,95
2	11,80	3,10	3,81	11,40	3,31	3,44	11,00	3,53	3,12	10,60	3,74	2,83	—	—	—	9,10	4,08	2,23
7	12,00	2,10	5,71	12,00	2,53	4,74	12,00	2,96	4,05	12,00	3,39	3,54	—	—	—	12,00	4,10	2,93
25	12,00	1,38	8,70	12,00	1,66	7,23	11,80	1,94	6,08	11,70	2,23	5,25	—	—	—	11,40	2,74	4,16
WH-MDC16G6E5																		
Tamb	HC	IP	COP	HC	IP	COP	HC	IP	COP	HC	IP	COP	HC	IP	COP	HC	IP	COP
LWC	30	30	30	35	35	35	40	40	40	45	45	45	50	50	50	55	55	55
-15	10,60	4,09	2,59	10,30	4,38	2,35	10,00	4,67	2,14	9,70	4,96	1,96	—	—	—	7,90	4,84	1,63
-7	11,90	4,03	2,95	11,40	4,43	2,57	10,80	4,83	2,24	10,30	5,22	1,97	—	—	—	9,00	4,88	1,84
2	13,50	3,74	3,61	13,00	3,96	3,28	12,40	4,18	2,97	11,90	4,40	2,70	—	—	—	9,80	4,44	2,21
7	16,00	3,21	4,98	16,00	3,74	4,28	16,00	4,27	3,75	16,00	4,80	3,33	—	—	—	14,50	5,33	2,72
25	16,00	2,31	6,93	16,00	2,69	5,95	16,00	3,07	5,21	16,00	3,45	4,64	—	—	—	15,90	3,89	4,09

Tamb: Ambient Temperature (°C). LWC: Leaving Water Condenser Temperature (°C). HC: Heating Capacity (kW). CC: Cooling Capacity (kW). IP: Power Input (kW)  
This data is measured by Panasonic in accordance with EN14511-2 standard. This data is for reference purpose only, and does not guarantee the performance.

## Cooling capacity table

Aquarea G Generation High Performance Mono-bloc Single Phase. Heating and Cooling - MDC

WH-MDC05F3E5									
Tamb	CC	IP	EER	CC	IP	EER	CC	IP	EER
LWC	7	7	7	14	14	14	18	18	18
18	1,95	0,45	4,33	2,20	0,45	4,89	2,45	0,50	4,90
25	5,00	1,25	4,00	6,30	1,20	5,25	6,30	0,80	7,88
35	4,50	1,35	3,33	5,10	1,50	3,40	5,00	1,00	5,00
43	3,75	1,75	2,14	4,50	1,80	2,50	4,25	1,20	3,54
WH-MDC06G3E5									
Tamb	CC	IP	EER	CC	IP	EER	CC	IP	EER
LWC	7	7	7	14	14	14	18	18	18
18	4,64	0,91	5,10	5,83	0,99	5,89	6,74	0,94	7,17
25	5,85	1,43	4,09	9,55	1,73	5,52	9,81	1,68	5,84
35	5,50	2,03	2,71	6,70	2,06	3,25	7,30	2,05	3,56
43	4,56	2,34	1,95	6,31	2,47	2,55	7,14	2,45	2,91
WH-MDC09G3E5									
Tamb	CC	IP	EER	CC	IP	EER	CC	IP	EER
LWC	7	7	7	14	14	14	18	18	18
18	5,36	1,05	5,10	6,12	1,08	5,67	7,02	1,08	6,50
25	6,44	1,85	3,48	10,50	2,51	4,18	11,16	2,52	4,43
35	7,00	2,90	2,41	8,40	2,95	2,85	9,00	3,00	3,00
43	5,32	3,18	1,67	6,34	2,48	2,56	6,78	2,46	2,76
WH-MDC12G6E5									
Tamb	CC	IP	EER	CC	IP	EER	CC	IP	EER
LWC	7	7	7	14	14	14	18	18	18
18	7,86	1,18	6,66	13,15	2,05	6,41	10,00	1,73	5,78
25	12,08	2,90	4,17	15,70	3,05	5,15	10,00	1,97	5,08
35	10,00	3,56	2,81	12,00	3,67	3,27	10,00	2,15	4,65
43	7,80	3,80	2,05	11,10	3,19	3,48	8,00	2,85	2,81
WH-MDC16G6E5									
Tamb	CC	IP	EER	CC	IP	EER	CC	IP	EER
LWC	7	7	7	14	14	14	18	18	18
18	9,20	1,62	5,68	16,40	2,58	6,36	12,20	2,45	4,98
25	14,40	3,92	3,67	19,20	3,83	5,01	12,20	2,79	4,37
35	12,20	4,76	2,56	15,00	4,98	3,01	12,20	2,96	4,12
43	7,75	3,40	2,28	13,80	5,95	2,32	9,70	4,00	2,43

Tamb: Ambient Temperature (°C). LWC: Leaving Water Condenser Temperature (°C). HC: Heating Capacity (kW). CC: Cooling Capacity (kW). IP: Power Input (kW)  
This data is measured by Panasonic in accordance with EN14511-2 standard. This data is for reference purpose only, and does not guarantee the performance.

# HEATING & COOLING CAPACITY TABLES

Based on outlet temperature and outside temperature

## Heating capacity table

Aquarea G Generation T-CAP Mono-bloc Single Phase / Three Phase. Heating and Cooling - MXC

WH-MXC09G3E5 / WH-MXC09G3E8																		
Tamb	HC	IP	COP	HC	IP	COP	HC	IP	COP	HC	IP	COP	HC	IP	COP	HC	IP	COP
LWC	30	30	30	35	35	35	40	40	40	45	45	45	50	50	50	55	55	55
-15	9,00	3,24	2,78	9,00	3,51	2,56	9,00	3,91	2,30	9,00	4,30	2,09	9,00	4,73	1,90	9,00	5,16	1,74
-7	9,00	2,71	3,32	9,00	3,16	2,85	9,00	3,62	2,49	9,00	4,07	2,21	9,00	4,27	2,11	9,00	4,46	2,02
2	9,00	2,36	3,81	9,00	2,51	3,59	9,00	2,78	3,24	9,00	3,05	2,95	9,00	3,56	2,53	9,00	4,07	2,21
7	9,00	1,64	5,49	9,00	1,86	4,84	9,00	2,16	4,17	9,00	2,46	3,66	9,00	2,76	3,26	9,00	3,06	2,94
25	13,60	1,50	9,07	13,60	1,71	7,95	13,20	1,93	6,84	12,80	2,14	5,98	12,00	2,41	4,98	11,20	2,67	4,19

WH-MXC12G6E5 / WH-MXC12G9E8																		
Tamb	HC	IP	COP	HC	IP	COP	HC	IP	COP	HC	IP	COP	HC	IP	COP	HC	IP	COP
LWC	30	30	30	35	35	35	40	40	40	45	45	45	50	50	50	55	55	55
-15	12,00	4,75	2,53	12,00	4,96	2,42	12,00	5,41	2,22	11,00	5,38	2,04	10,80	5,82	1,86	10,50	6,26	1,68
-7	12,00	3,85	3,12	12,00	4,41	2,72	12,00	4,98	2,41	12,00	5,54	2,17	12,00	5,90	2,03	12,00	6,26	1,92
2	12,00	3,19	3,76	12,00	3,49	3,44	12,00	3,87	3,10	12,00	4,25	2,82	12,00	4,86	2,47	12,00	5,47	2,19
7	12,00	2,18	5,50	12,00	2,53	4,74	12,00	2,96	4,05	12,00	3,39	3,54	12,00	3,78	3,17	12,00	4,16	2,88
25	13,60	1,55	8,77	13,60	1,76	7,73	13,40	2,10	6,38	13,20	2,43	5,43	12,60	2,66	4,74	12,00	2,89	4,15

WH-MXC16G9E8																		
Tamb	HC	IP	COP	HC	IP	COP	HC	IP	COP	HC	IP	COP	HC	IP	COP	HC	IP	COP
LWC	30	30	30	35	35	35	40	40	40	45	45	45	50	50	50	55	55	55
-15	16,00	6,30	2,54	16,00	6,89	2,32	16,00	7,45	2,15	16,00	8,10	1,98	16,00	8,48	1,89	15,20	8,96	1,70
-7	16,00	5,85	2,74	16,00	6,42	2,49	16,00	7,00	2,29	16,00	7,57	2,11	16,00	8,10	1,98	16,00	8,62	1,86
2	16,00	4,67	3,43	16,00	5,21	3,07	16,00	5,74	2,79	16,00	6,31	2,54	16,00	6,90	2,32	16,00	7,50	2,13
7	16,00	3,35	4,78	16,00	3,74	4,28	16,00	4,30	3,72	16,00	4,80	3,33	16,00	5,43	2,95	16,00	5,91	2,71
25	16,00	2,02	7,92	16,00	2,58	6,20	16,00	2,91	5,49	16,00	3,36	4,76	16,00	3,74	4,28	16,00	4,00	4,00

## Cooling capacity table

Aquarea G Generation T-CAP Mono-bloc Single Phase / Three Phase. Heating and Cooling - MXC

WH-MXC09G3E5 / WH-MXC09G3E8									
Tamb	CC	IP	EER	CC	IP	EER	CC	IP	EER
LWC	7	7	7	14	14	14	18	18	18
18	7,00	1,36	5,15	8,55	1,41	6,06	7,00	1,00	7,00
25	7,65	1,91	4,01	11,10	1,98	5,61	7,00	1,10	6,36
35	7,00	2,21	3,17	9,23	2,37	3,89	7,00	1,35	5,19
43	6,25	2,66	2,35	8,55	2,71	3,15	5,60	1,60	3,50

WH-MXC12G6E5 / WH-MXC12G9E8									
Tamb	CC	IP	EER	CC	IP	EER	CC	IP	EER
LWC	7	7	7	14	14	14	18	18	18
18	10,00	1,75	5,71	13,20	1,96	6,73	10,00	1,40	7,14
25	11,20	2,67	4,19	16,50	3,01	5,48	10,00	1,60	6,25
35	10,00	3,56	2,81	12,55	3,63	3,46	10,00	1,95	5,13
43	8,00	3,35	2,39	10,00	3,46	2,89	8,00	2,30	3,48

WH-MXC16G9E8									
Tamb	CC	IP	EER	CC	IP	EER	CC	IP	EER
LWC	7	7	7	14	14	14	18	18	18
18	8,50	1,70	5,00	—	—	—	10,00	1,70	5,88
25	14,00	4,00	3,50	—	—	—	14,00	2,94	4,76
35	12,20	4,76	2,56	—	—	—	12,20	3,50	3,49
43	7,10	3,31	2,15	—	—	—	9,80	3,31	2,96

Tamb: Ambient Temperature (°C). LWC: Leaving Water Condenser Temperature (°C). HC: Heating Capacity (kW). CC: Cooling Capacity (kW). IP: Power Input (kW)  
This data is measured by Panasonic in accordance with EN14511-2 standard. This data is for reference purpose only, and does not guarantee the performance.

## Heating capacity table

Aquarea G Generation HT Mono-bloc Single Phase / Three Phase. Heating Only - MHF

WH-MHF09G3E5																		
Tamb	HC	IP	COP	HC	IP	COP	HC	IP	COP	HC	IP	COP	HC	IP	COP	HC	IP	COP
LWC	30	30	30	35	35	35	40	40	40	45	45	45	50	50	50	55	55	55
-15	9,00	3,46	2,60	9,00	3,71	2,43	9,00	4,01	2,24	8,80	4,26	2,07	8,50	4,71	1,80	7,80	5,38	1,45
-7	9,00	3,06	2,94	9,00	3,29	2,74	9,00	3,56	2,53	8,90	3,83	2,32	8,90	4,28	2,08	9,00	5,02	1,79
2	9,00	2,43	3,70	9,00	2,61	3,45	9,00	2,91	3,09	9,00	3,21	2,80	9,00	3,72	2,42	9,00	4,37	2,06
7	9,00	1,82	4,95	9,00	1,94	4,64	9,00	2,21	4,07	9,00	2,46	3,66	9,00	2,99	3,01	9,00	3,64	2,47
25	9,00	1,52	5,92	9,00	1,70	5,29	9,00	1,88	4,79	9,00	2,16	4,17	9,00	2,63	3,42	9,00	3,20	2,81

WH-MHF12G6E5																		
Tamb	HC	IP	COP	HC	IP	COP	HC	IP	COP	HC	IP	COP	HC	IP	COP	HC	IP	COP
LWC	30	30	30	35	35	35	40	40	40	45	45	45	50	50	50	55	55	55
-15	12,00	5,16	2,33	12,00	5,53	2,17	11,00	5,51	2,00	10,80	5,49	1,97	9,70	5,52	1,76	8,00	5,61	1,43
-7	12,00	4,43	2,71	12,00	4,76	2,52	11,50	4,91	2,34	11,20	5,06	2,21	10,10	5,06	2,00	9,60	5,43	1,77
2	12,00	3,42	3,51	12,00	3,68	3,26	11,50	3,86	2,98	11,30	4,14	2,73	10,80	4,66	2,32	10,30	5,13	2,01
7	12,00	2,52	4,76	12,00	2,69	4,46	12,00	3,06	3,92	12,00	3,44	3,49	12,00	4,10	2,93	12,00	4,97	2,41
25	12,00	2,03	5,91	12,00	2,36	5,08	12,00	2,69	4,46	12,00	3,02	3,97	12,00	3,61	3,32	12,00	4,37	2,75

Tamb: Ambient Temperature (°C). LWC: Leaving Water Condenser Temperature (°C). HC: Heating Capacity (kW). CC: Cooling Capacity (kW). IP: Power Input (kW)  
This data is measured by Panasonic in accordance with EN14511-2 standard. This data is for reference purpose only, and does not guarantee the performance.



# EXAMPLES OF INSTALLATIONS

Aquarea H Generation: Bivalent with buffer tank and mixing valve

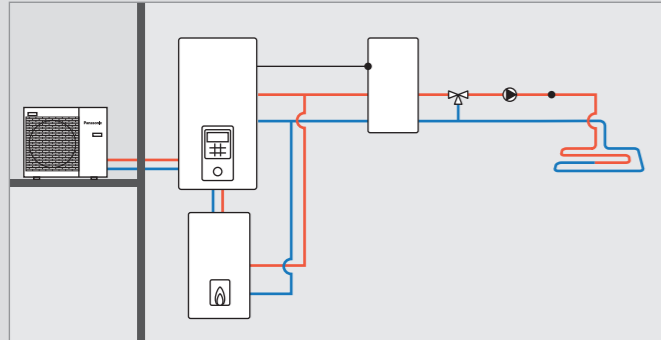

Aquarea H Generation: Buffer tank with solar and mixing valve

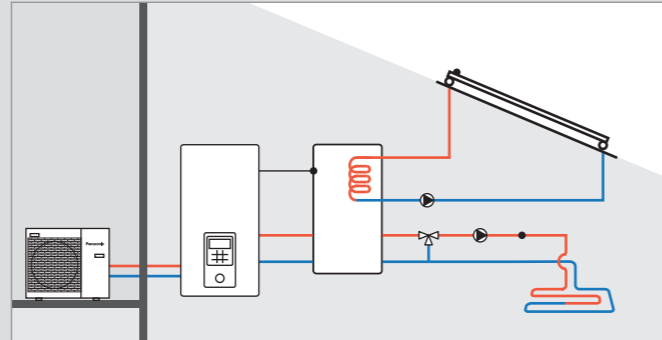

Aquarea H Generation: 2 zones with external kit without buffer tank

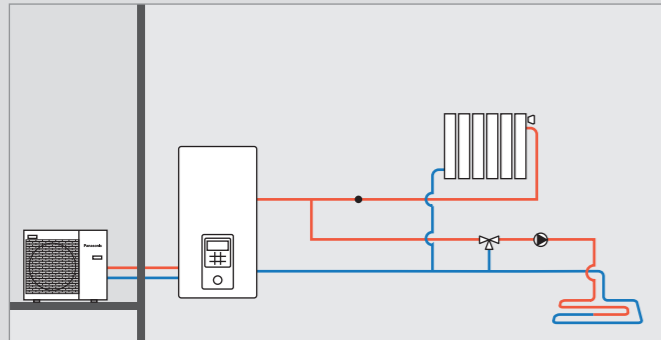

Aquarea H Generation: 2 zones with external kit, buffer tank and swimming pool

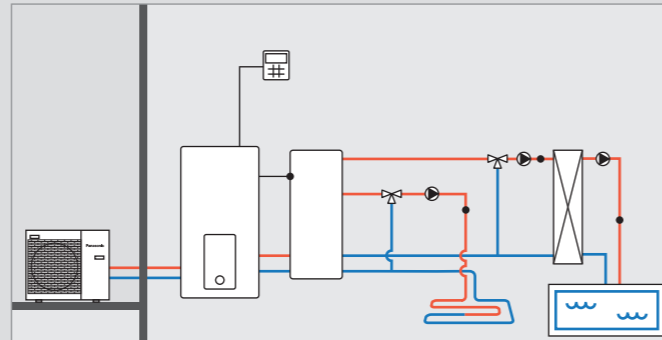

Aquarea All in One H Generation: 2 zones with external kit, without buffer tank

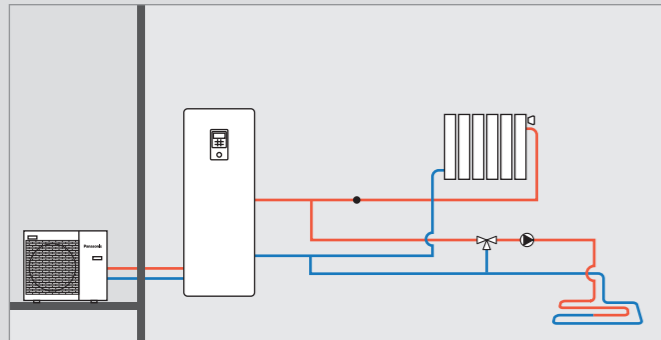

Aquarea All in One 2 zones H Generation: 2 zones built-in, without buffer tank

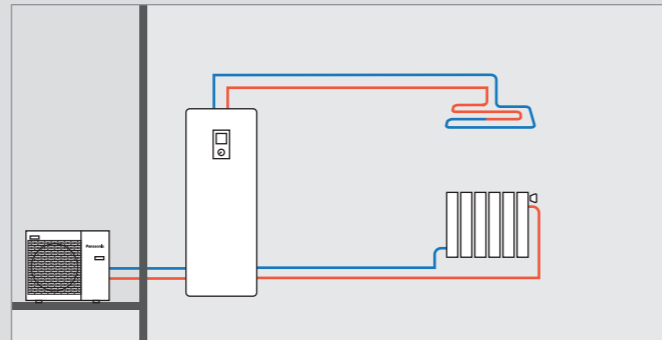

# DIMENSIONS

## All in One H Generation

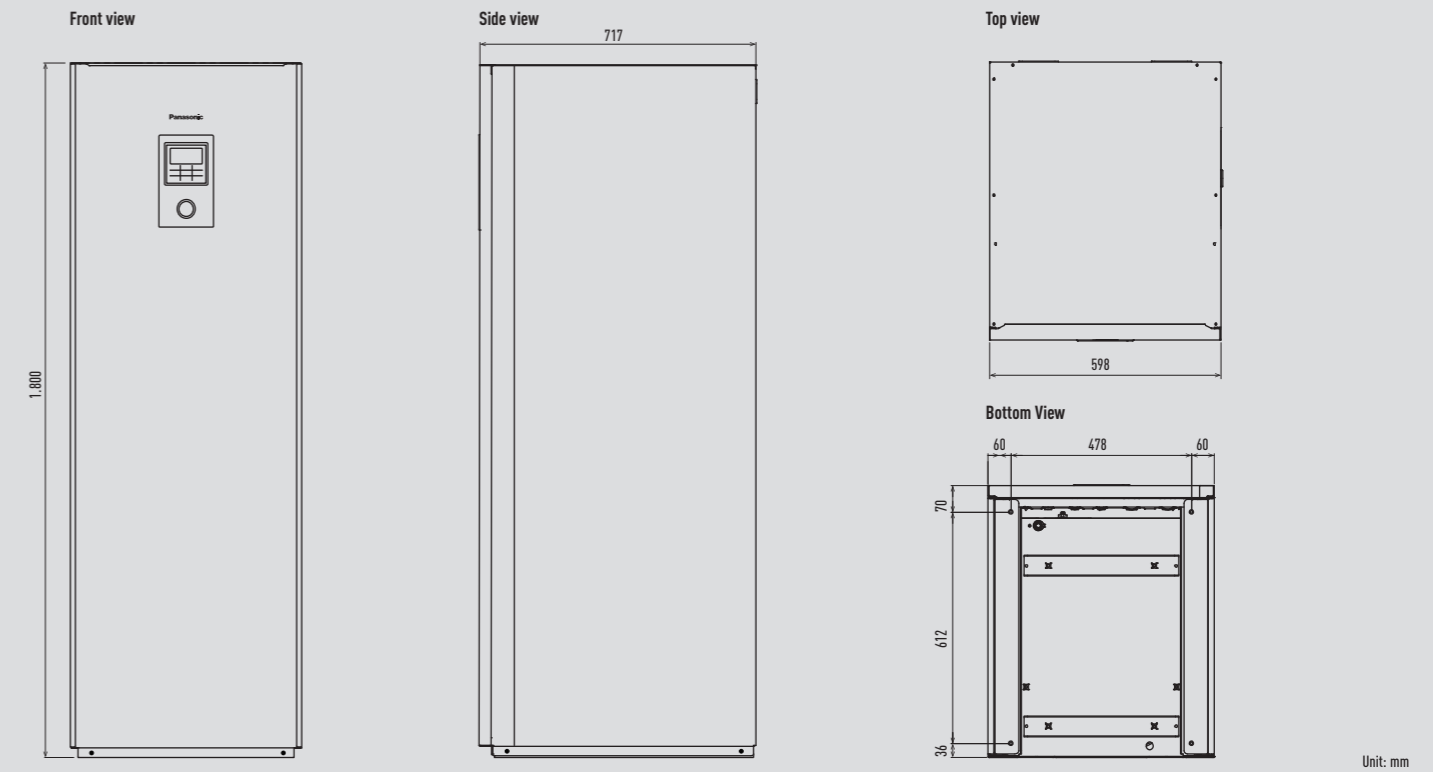

## All in One G Generation

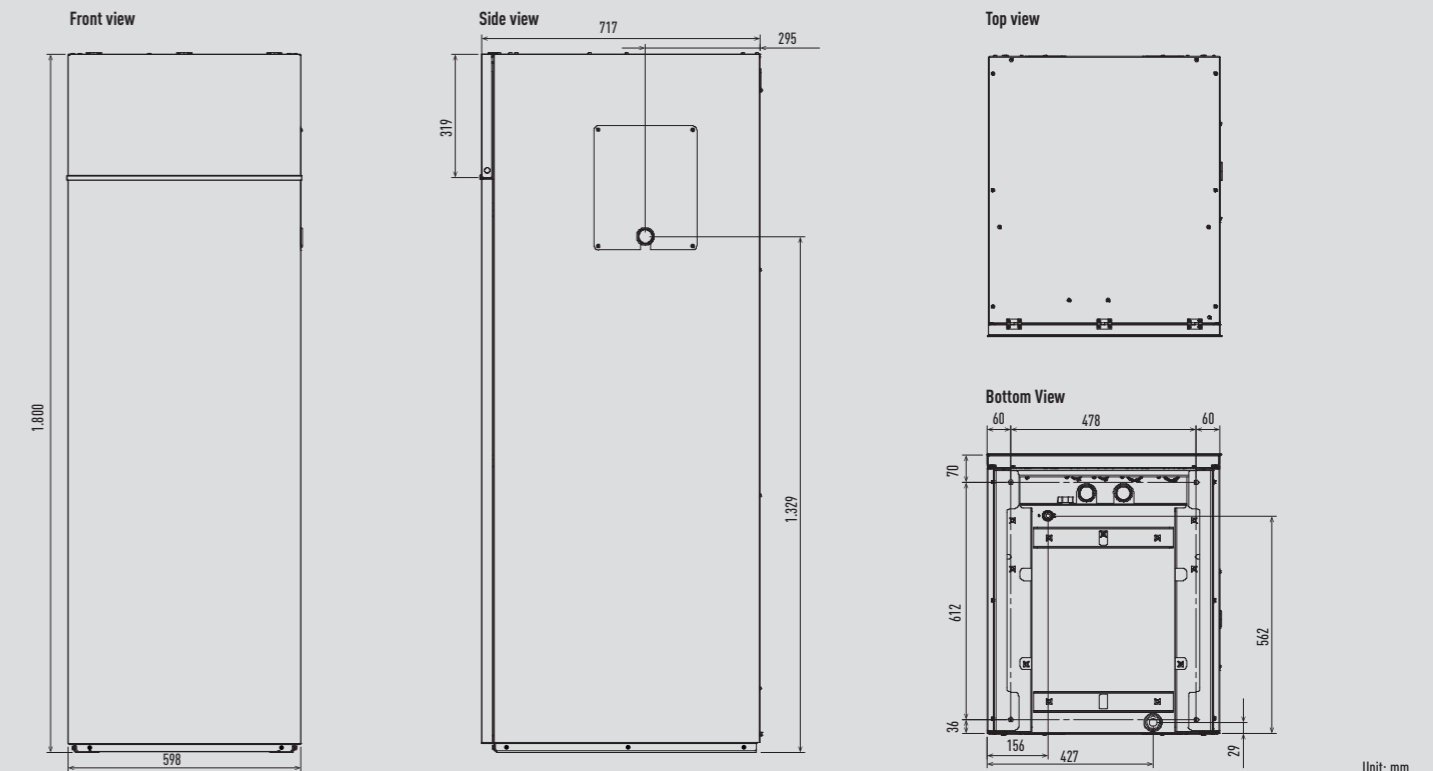

# DIMENSIONS

## Hydraulic Module H Generation

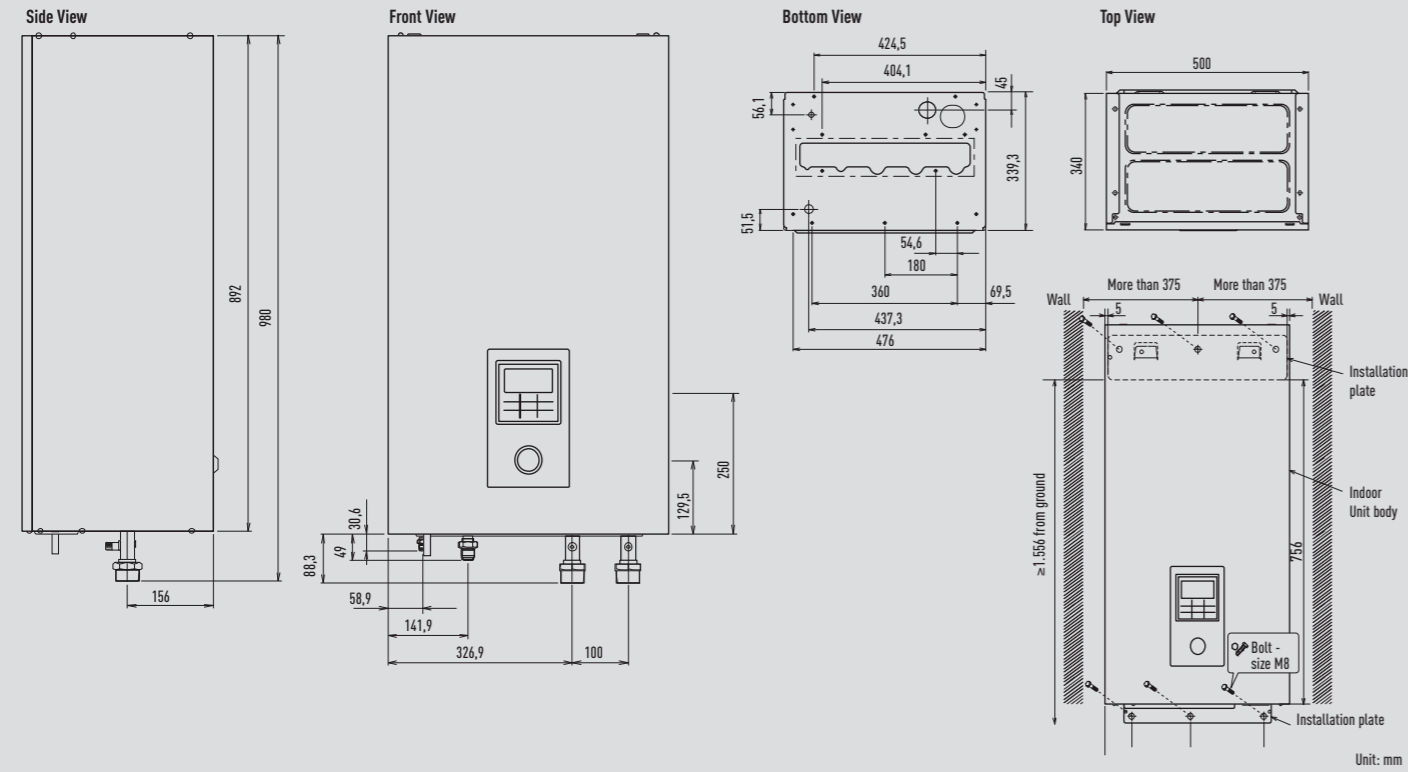

## Bi-bloc outdoor unit 3 and 5kW

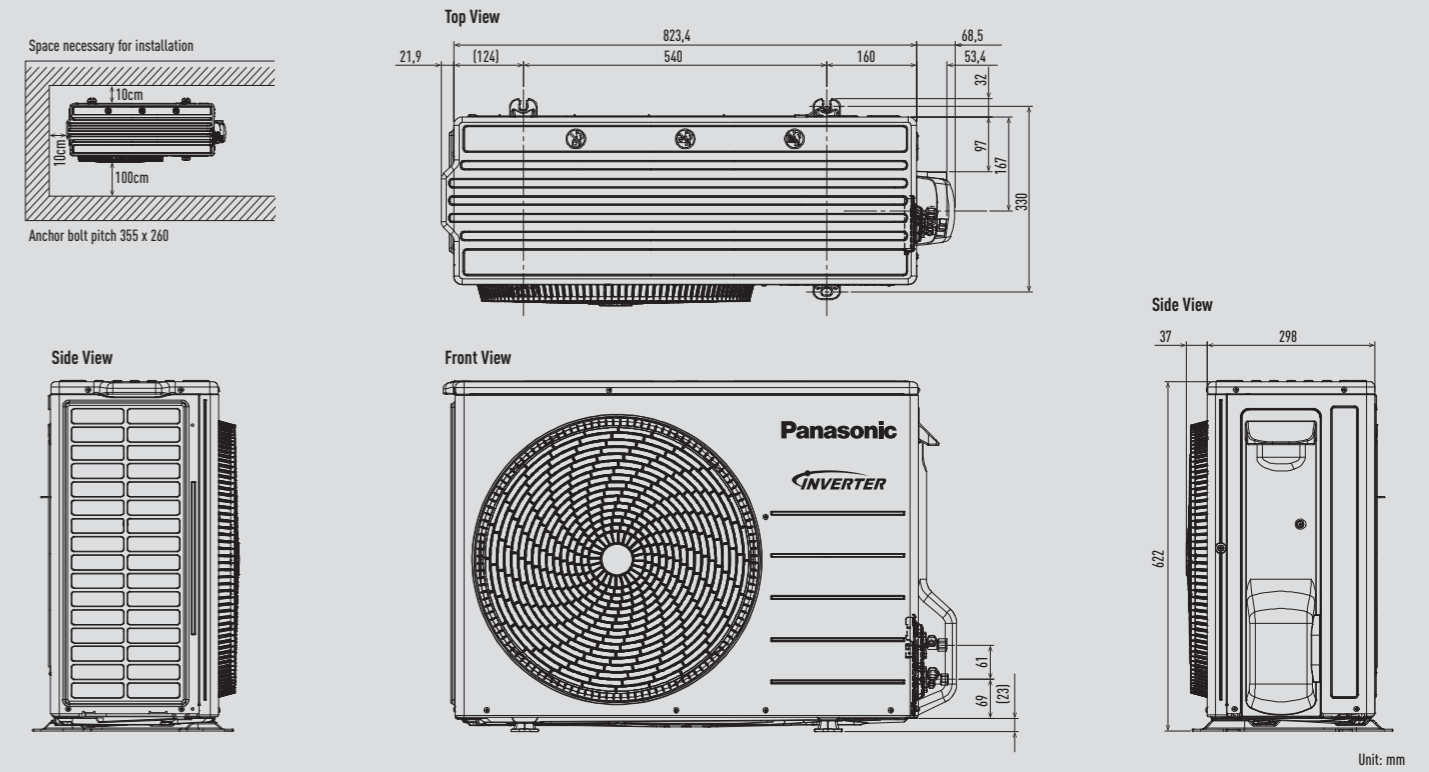

## Hydraulic Module F Generation

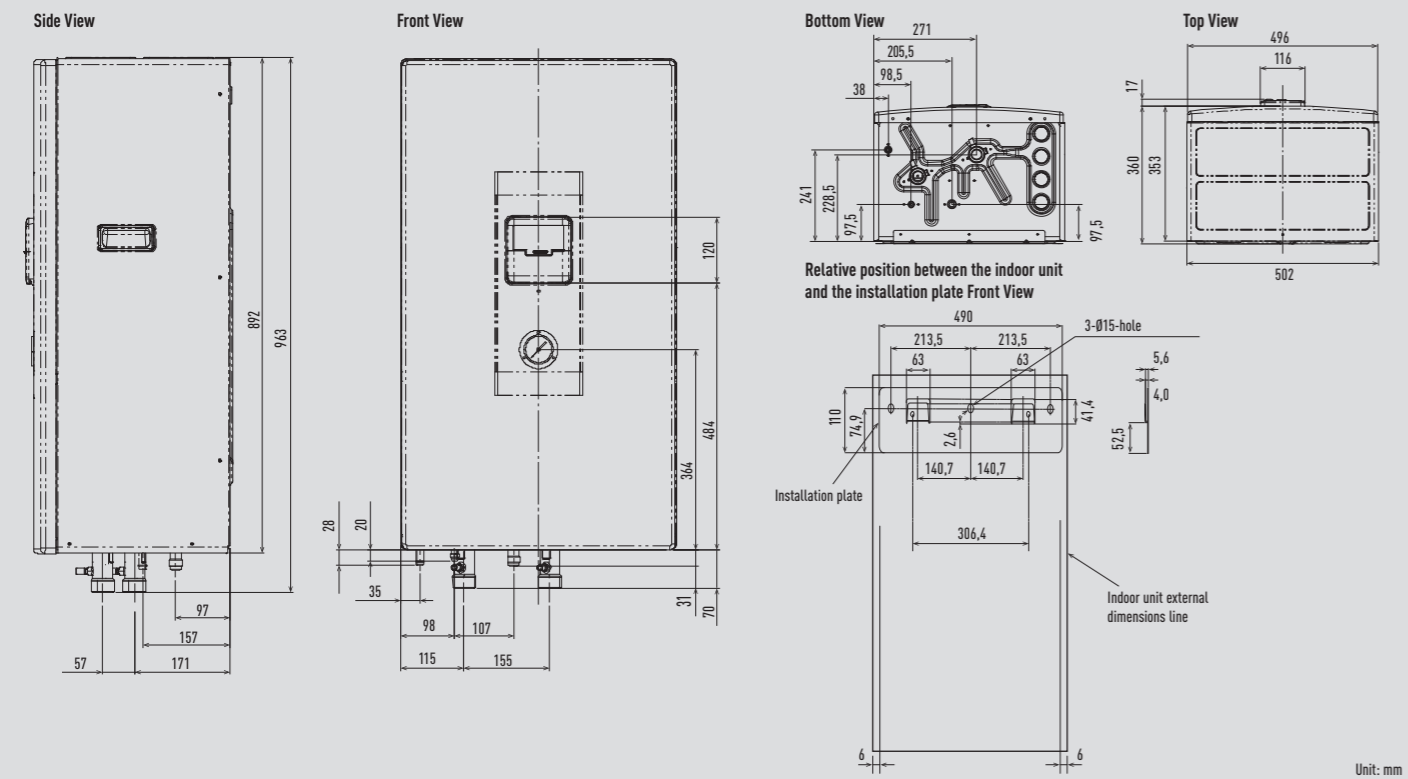

## Bi-bloc outdoor unit 7 and 9kW

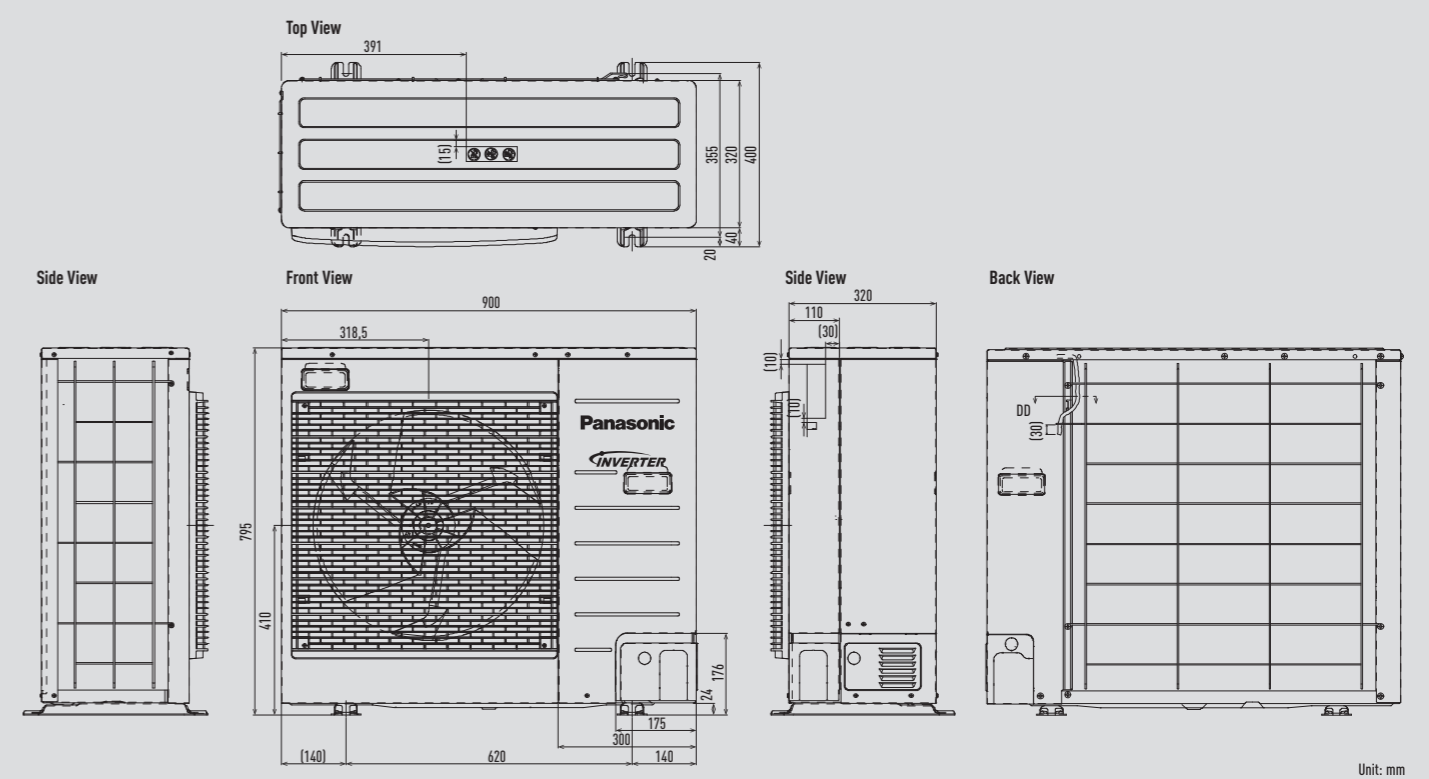

# DIMENSIONS

## Bi-bloc outdoor unit from 9 to 16kW

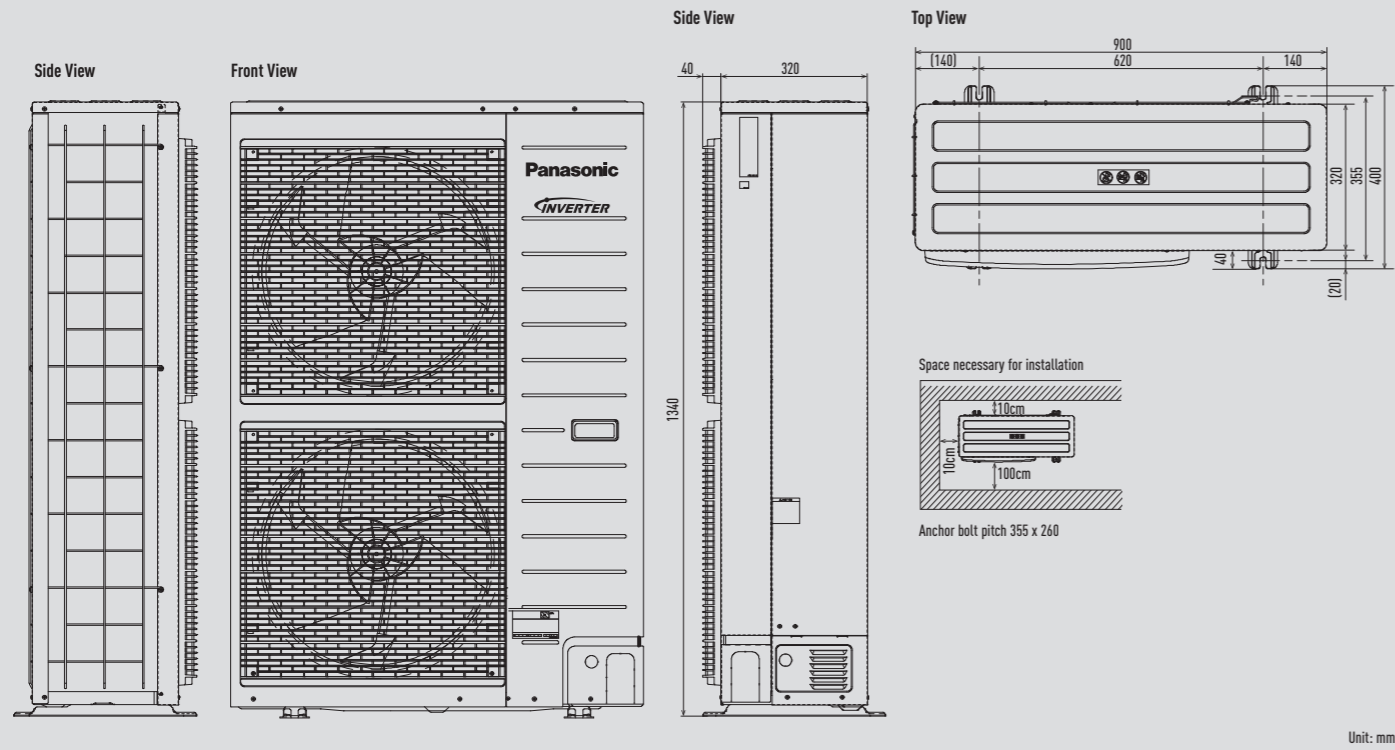

## Bi-bloc Super Quiet outdoor unit and Mono-bloc outdoor unit from 9 to 16kW

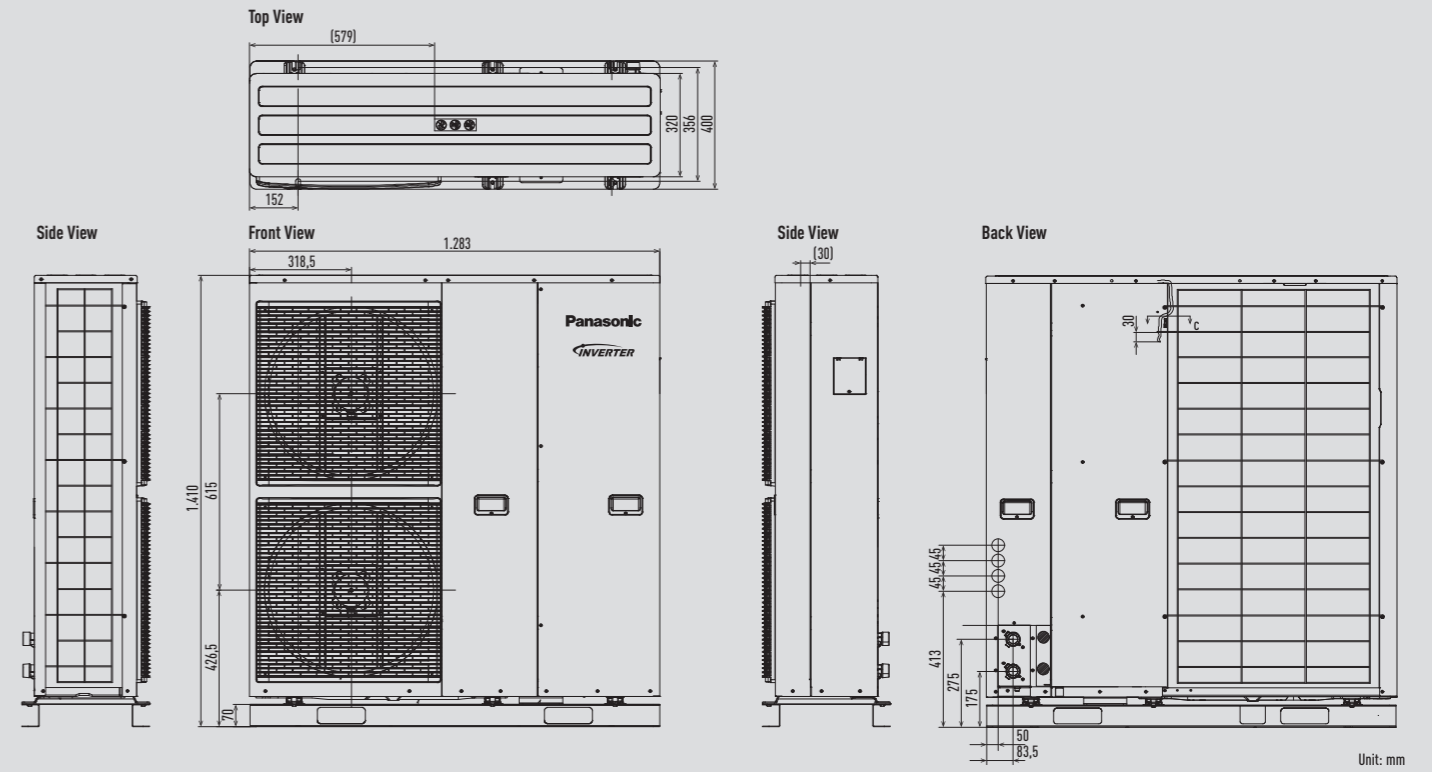

## Mono-bloc outdoor unit from 5 to 9kW

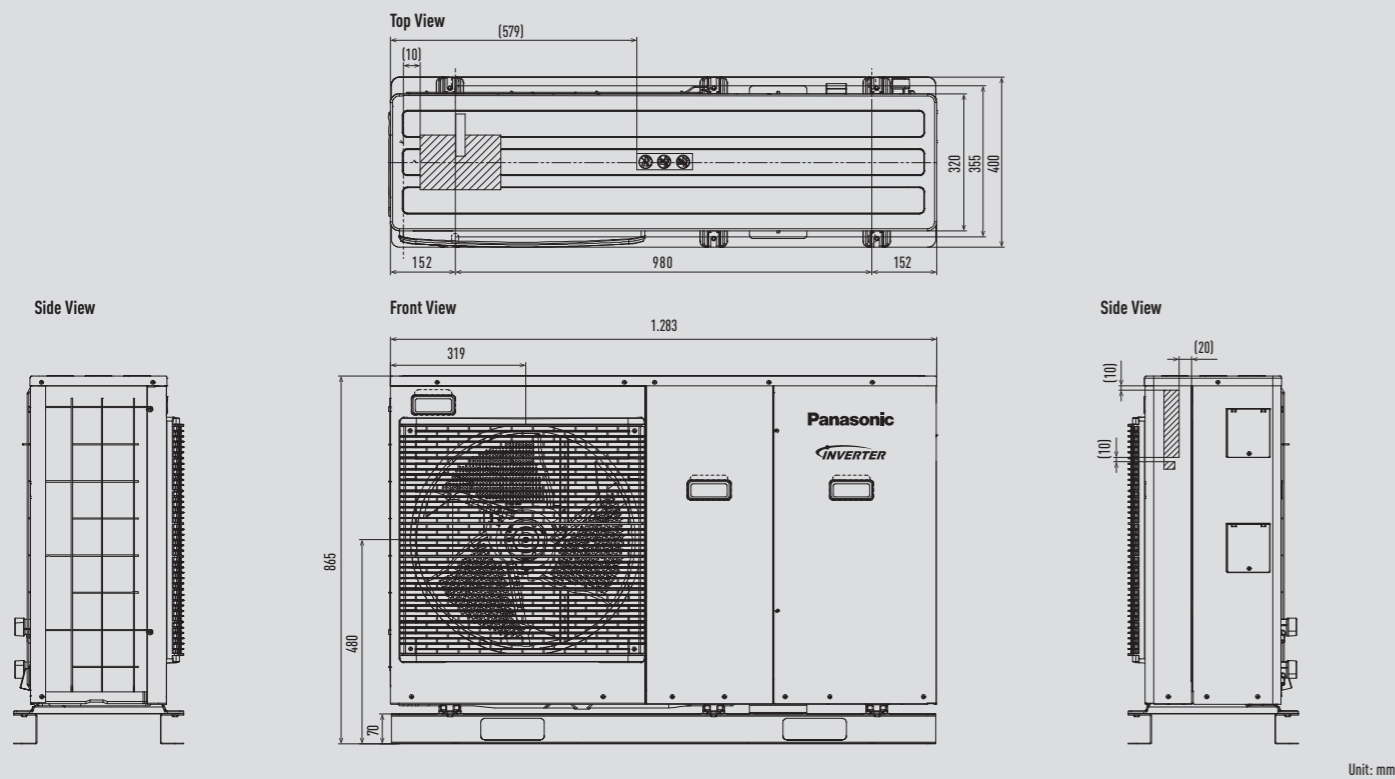

## Aquarea DHW Floor standing

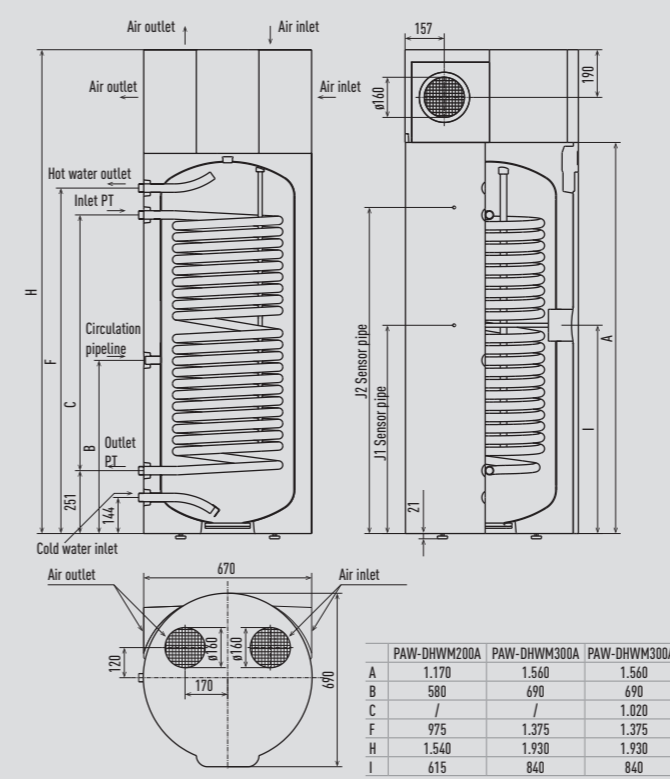

## Aquarea DHW Wall mounted

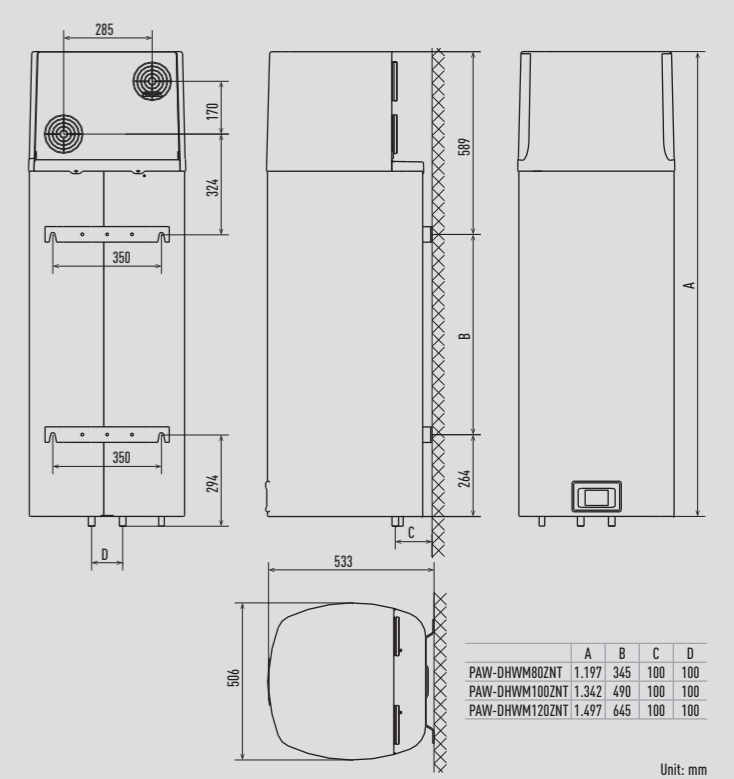







[www.aircon.panasonic.eu](http://www.aircon.panasonic.eu)

heating & cooling solutions



Due to the ongoing innovation of our products, the specifications of this catalogue are valid barring typographic errors, and may be subject to minor modifications by the manufacturer without prior warning in order to improve the product. The total or partial reproduction of this catalogue is prohibited without the express authorisation of Panasonic Marketing Europe GmbH.

# Panasonic®

To find out how Panasonic cares for you,  
log on to: [www.aircon.panasonic.eu](http://www.aircon.panasonic.eu)

Panasonic Marketing Europe GmbH  
Panasonic Air Conditioning  
Hagenauer Strasse 43, 65203 Wiesbaden, Germany



Do not add or replace refrigerant other than the specified type. Manufacturer is not responsible for the damage and deterioration in safety due to usage of the other refrigerant.  
The outdoor units in this catalogue contains fluorinated greenhouse gases with a GWP higher than 150.

