

Air to Water Heat Pump

Installation manual

Outdoor Unit AE***RXEDEG

- Thank you for purchasing this Samsung Product.
- Before operating this unit, please read this installation manual carefully and retain it for future reference.



DB68-08375A-01

SAMSUNG

Contents

PREPARATION

Safety precautions	3
Product specifications	5

INSTALLATION

Outdoor unit specification	6
Main components	7
Installing the unit	8
Electrical connections	19
Connecting the cable	20
Refrigerant piping work	26
Checking correct grounding	39
Setting the option switch and function of the keys	39
Pump down procedure	44
Completing the installation	46
Final checks and trial operation	47

OTHERS

Trouble shooting	48
Error codes	48



Correct Disposal of This Product (Waste Electrical & Electronic Equipment)

(Applicable in countries with separate collection systems)

This marking on the product, accessories or literature indicates that the product and its electronic accessories (e.g. charger, headset, USB cable) should not be disposed of with other household waste at the end of their working life. To prevent possible harm to the environment or human health from uncontrolled waste disposal, please separate these items from other types of waste and recycle them responsibly to promote the sustainable reuse of material resources.

Household users should contact either the retailer where they purchased this product, or their local government office, for details of where and how they can take these items for environmentally safe recycling.

Business users should contact their supplier and check the terms and conditions of the purchase contract. This product and its electronic accessories should not be mixed with other commercial wastes for disposal.

Safety precautions

Carefully follow the precautions listed as below because they are essential to guarantee the safety of SAMSUNG product.



WARNING

- Always disconnect a power supply of Air-Water Heat Pump before servicing it or accessing components inside the unit.
- Verify that installation and testing operations shall be performed by qualified personnel.
- To prevent serious damage on the system and injuries to users, precautions and other notices shall be observed.

Warning

- ▶ Carefully read the content of this manual before installing the air to water heat pump and store the manual in a safe place in order to be able to use it as reference after installation.
- ▶ For maximum safety, installers should always carefully read the following warnings.
- ▶ Store the operation and installation manual in a safe location and remember to hand it over to the new owner if the Air to Water Heat pump is sold or transferred.
- ▶ Store the user and installation manual in a safe location and remember to hand it over to the new owner if the air to water heat pump is sold or transferred.
- ▶ This manual explains how to install Air-Water Heat Pump. The use of other types of units with different control systems may damage the units and invalidate the warranty. The manufacturer shall not be responsible for damages arising from the use of non compliant units.
- ▶ The manufacturer shall not be responsible for damage originating from unauthorized changes or the improper connection of electric and hydraulic lines. Failure to comply with these instructions or to comply with the requirements set forth in the "Operating limits" table, included in the manual, shall immediately invalidate the warranty.
- ▶ Failure to comply with these instructions or to comply with the requirement on the Operating Range (Heat : -25~35 °C/ Cool: 10~46 °C) set forth in the Product Specification (p.6) shall immediately invalidate the warranty.
- ▶ Do not use the units if you see some damages on the units and recognize something bad such as loud noisy, smell of burning.
- ▶ In order to prevent electric shocks, fires or injuries, always stop the unit, disable the protection switch and contact SAMSUNG's technical support if the unit produces smoke, if the power cable is hot or damaged or if the unit is very noisy.
- ▶ Always remember to inspect the unit, electric connections, refrigerant tubes and protections regularly. These operations shall be performed by qualified personnel only.
- ▶ The unit contains moving parts and electrical parts, which should always be kept out of the reach of children.
- ▶ Do not attempt to repair, move, alter or reinstall the unit by unauthorized personnel, these operations may cause product damage, electric shocks and fires.
- ▶ Do not place containers with liquids or other objects on the unit.
- ▶ All the materials used for the manufacture and packaging of the air to water heat pump are recyclable.
- ▶ The packing material and exhaust batteries of the remote controller(optional) must be disposed of in accordance with local regulations.
- ▶ The air to water heat pump contains a refrigerant that has to be disposed of as special waste. At the end of its life cycle, the heat pump must be disposed of in authorized centers or returned to the retailer so that it can be disposed of correctly and safely.
- ▶ Wear protective gloves to unpack, move, install, and service the unit to avoid your hands being injured by the edge of the parts.
- ▶ Do not touch the internal parts (water pipes, refrigerant pipes, heat exchangers, etc) while running the units. And if you need to adjust and touch the units, have enough time for the unit can be cooled and be sure to wear protective gloves.
- ▶ In case of refrigerant leakage, try to avoid getting in contact with the refrigerant because this could result in severe wounds.

Safety precautions

- ▶ When you install the Air to water heat pump in a small room, you must consider a proper ventilation to prevent a leakage level within the maximum permissible limit.
 - In that case, you may die from suffocation by some possibility.
- ▶ Make sure to safely dispose of packing materials. Packing materials, such as nails and other metal or wooden pallets may cause children get injured.
- ▶ Inspect the product shipped and check if damaged during transport. If the product has some damages, DO NOT INSTALL and immediately discuss about the damages with the carrier or retailer (if the installer or the authorized technician has collected the material from the retailer.)
- ▶ Our units shall be installed in compliance with the spaces described in the installation manual, to ensure accessibility from both sides and allow repairs or maintenance operations to be carried out. If the units installed without complying with procedures described in manual, additional expenses can be asked because special harnesses, ladders, scaffolding or any other elevation system for repair service will NOT be considered part of the warranty and will be charged to the end customer.
- ▶ Always make sure that the power supply is compliant with local safety standards.
- ▶ Verify that the voltage and frequency of the power supply comply with the specifications and input power is sufficient to ensure the operation of any other domestic appliance connected to the same electric lines. Always verify that the cut-off and protection switches are suitably selected.
- ▶ Always verify that electric connections (cable entry, section of leads, protections. . .) are compliant with the electric specifications and with the instructions provided in the wiring scheme. Always verify that all connections comply with the standards applicable to the installation of air to water heat pumps. Devices disconnected from the power supply should be completely disconnected in the condition of overvoltage category.
- ▶ Do not connect the earth wire to the gas pipe or water pipe, lighting rod, surge absorber, or telephone earth wire. If earthing is not complete, it may cause an electric shock or fire.
- ▶ Be sure to install both an earth leakage detector and circuit breaker with specified capacity in accordance with relevant local and national regulations.
 - If it is not installed properly, it may cause electric shocks and fire.
- ▶ Make sure that the condensed water runs well out of the unit at low ambient temperature. Drain pipe and cond heater frost/ice can not grow. If drain work is not effective for releasing condensed water, it can make the units get damaged by massive ice and system can be stop , covered by ice.
- ▶ Install the power cable and communication cable of the indoor and outdoor unit at least 1 m away from the electric appliance.
- ▶ Protect the unit from rats or small animals. If an animal makes a contact with the electric parts, it can cause malfunctions, smoke or fire. Please instruct the customer to keep the area around the unit clean.
- ▶ Do not disassemble and alter the heater at your own discretion.
- ▶ This appliance is not intended for use by persons (including children) with reduced physical, sensory or mental capabilities, or lack of experience and knowledge, unless they have been given supervision or instruction concerning use of the appliance by a person responsible for their safety. Children should be supervised to ensure that they do not play with the appliance.
- ▶ **For use in Europe :** This appliance can be used by children aged from 8 years and above and persons with reduced physical, sensory or mental capabilities or lack of experience and knowledge if they have been given supervision or instruction concerning use of the appliance in a safe way and understand the hazards involved. Children shall not play with the appliance. Cleaning and user maintenance shall not be made by children without supervision.
- ▶ Be sure not to perform power cable modification, extension wiring, and multiple wire connection.
 - It may cause electric shock or fire due to poor connection, poor insulation, or current limit override.
 - When extension wiring is required due to power line damage, refer to "How to connect your extended power cables" in the installation manual.
- ▶ Do not use means to accelerate the defrost operation or to clean, other than those recommended by Samsung.
- ▶ Do not pierce or burn.
- ▶ Be aware that refrigerants may not contain an odour.





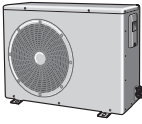

Product specifications

Product line-up

Line-up		Remark
Heat pump units	Chassis	 AE040RXEDEG AE060RXEDEG
	Model name	

Accessories

- ▶ Keep supplied accessories until the installation is finished.
- ▶ Hand the installation manual over to the customer after finishing installation.
- ▶ The quantities are indicated in parentheses.
- ▶ The base heater inside outdoor unit works in accordance with the weather of outdoor.

Installation manual (1) 	Drain plug (1) 	Rubber Leg(4) 
Manual Instruction (1) 	Drain cap (4) 	Wire for silent model 

Outdoor unit specification

Type	Unit	AE040RXEDEG
Power source	-	1P, 220~240 Vac, 50 Hz
Weight (net/gross)	kg	46.5 / 49.5
Size (WxHxD, net)	mm	880 x 638 x 310
Noise (Heat/Cool, Pressure)	dB(A)	44 / 46
Operating Range (Heat/Cool)	°C	-25~35/10~46
Refrigerant	g	1,200 (R-32)

Type	Unit	AE060RXEDEG
Power source	-	1P, 220~240 Vac, 50 Hz
Weight (net/gross)	kg	46.5 / 49.5
Size (WxHxD, net)	mm	880 x 638 x 310
Noise (Heat/Cool, Pressure)	dB(A)	47 / 47
Operating Range (Heat/Cool)	°C	-25~35/10~46
Refrigerant	g	1,200 (R-32)

* At the temperature -25 °C ~ -20 °C, operation is available but capacity cannot be guaranteed.

Main components

Dimensions(Overall)

Heat pump for R-32.

1-Fan chassis

▶ AE040/060RXEDEG

(Unit : mm)

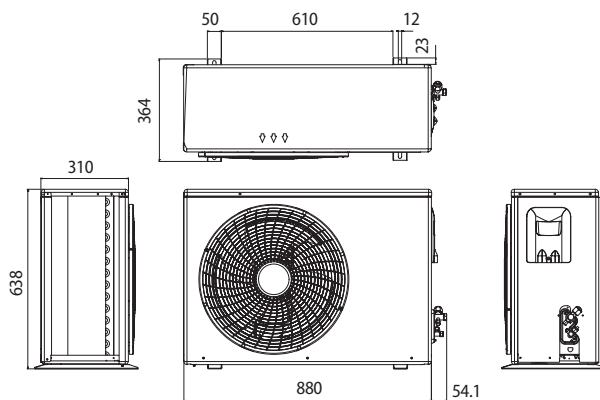
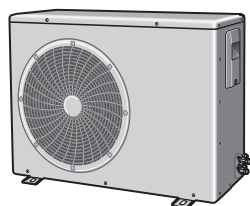

Installing the unit

Deciding on where to install the outdoor unit

Decide the installation location regarding the following condition and obtain the user's approval.

- ▶ The outdoor unit must not be placed on its side or upside down, as the compressor lubrication oil will run into the cooling circuit and seriously damage the unit.
- ▶ Choose a location that is dry and sunny, but not exposed to direct sunlight or strong winds.
- ▶ Do not block any passageways or thoroughfares.
- ▶ Choose a location where the noise of the Air to Water Heat Pump when running and the discharged air do not disturb any neighbours.
- ▶ Choose a position that enables the pipes and cables to be easily connected to the other hydraulic system.
- ▶ Install the outdoor unit on a flat, stable surface that can support its weight and does not generate any unnecessary noise and vibration.
- ▶ Position the outdoor unit so that the air flow directly stream towards the open area.
- ▶ Place the outdoor unit where there are no plants and animals because they may cause malfunction of outdoor unit.
- ▶ Maintain sufficient clearance around the outdoor unit, especially from a radio, computer, stereo system, etc.

Installation Guide at the seashore

Make sure to follow below guides when installing at the seashore.

1. Do not install the product in a place where it is directly exposed to sea water and sea breeze.
 - Make sure to install the product behind a structure (such as building) that can block sea breeze.
 - Even when it is inevitable to install the product in seashore, make sure that product is not directly exposed to sea breeze by installing a protection wall.
 2. Consider that the salinity particles clinging to the external panels should be sufficiently washed out.
 3. Because the residual water at the bottom of the outdoor unit significantly promotes corrosion, make sure that the slope does not disturb drainage.
 - Keep the floor level so that rain does not accumulate.
 - Be careful not to block the drain hole due to foreign substance
 4. When product is installed in seashore, periodically clean it with water to remove attached salinity.
 5. Make sure to install the product in a place that provides smooth water drainage. Especially, ensure that the base part has good drainage.
 6. If the product is damaged during the installation or maintenance, make sure to repair it.
 7. Check the condition of the product periodically.
 - Check the installation site every 3 months and perform anti-corrosion treatment such as R-Pro supplied by SAMSUNG (Code : MOK-220SA) or commercial water repellent grease and wax, etc., based on the product condition.
 - When the product is to be shut down for a long period of time, such as off-peak hours, take appropriate measures like covering the product.
 8. If the product installed within 500m of seashore, special anti-corrosion treatment is required.
- * Please contact your local SAMSUNG representative for further details.

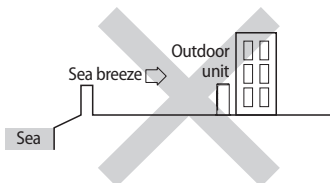

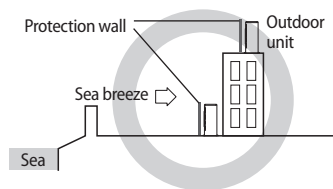
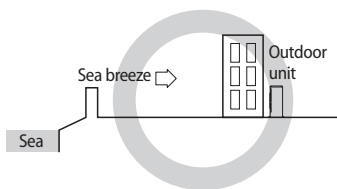

Protection wall should be constructed with a solid material that can block the sea breeze and the height and width of the wall should be 1.5 times larger than the size of the outdoor unit. (You must secure more than 700mm of space between the protection wall and the outdoor unit for air circulation.)



- Depending on the condition of power supply, unstable power or voltage may cause malfunction of the parts or control system. (At the ship or places using power supply from electric generator, etc).

- ▶ Do not install the Air to Water Heat Pump in following places.
 - The place where there is mineral oil or arsenic acid. There is a chance that parts may get damaged due to burned resin. The capacity of the heat exchanger may reduce or the Air to Water Heat pump may be out of order.
 - The place where corrosive gas such as sulfurous acid gas generates from the vent pipe or air outlet. The copper pipe or connection pipe may corrode and refrigerant may leak.
 - The place where there is a danger of existing combustible gas, carbon fiber or flammable dust. The place where thinner or gasoline is handled.



- This device must be installed according to the national electrical rules.
- With an outdoor unit having net weight upper than 60 kg, we suggest do not install it suspended on wall, but considering floor standing one.

- ▶ If the outdoor unit is installed at a height, ensure that its base is firmly fixed in position.
- ▶ Make sure that the water dripping from the drain hose runs away correctly and safely.
- ▶ When you install the outdoor unit at wayside, you should install it above 2 m height or make sure that the heat from the outdoor unit shouldn't be in direct contact with passersby. (The ground for application :The revision of regulation for facility in building by the law of the Ministry of Construction and Transportation.
- ▶ While in installation or relocation of the product, do not mix the refrigerant with other gases including air or unspecified refrigerant. Failure to do so may cause pressure increase to result in rupture or injury.
- ▶ Do not cut or burn the refrigerant container or pipings.
- ▶ Use clean parts such as manifold gauge, vacuum pump, and charging hose for the refrigerant.
- ▶ Installation must be carried out by qualified personnel for handling the refrigerant. Additionally, reference the regulations and laws.
- ▶ Be careful not to let foreign substances (lubricating oil, refrigerant other than R-32, water, etc.) enter the pipings.
- ▶ When mechanical ventilation is required, ventilation openings shall be kept clear of obstruction.
- ▶ For disposal of the product, follow the local laws and regulations.
- ▶ Do not work in a confined place.
- ▶ The work area shall be blocked.
- ▶ The refrigerant pipings shall be installed in the position where there are no substances that may result in corrosion.
- ▶ The following checks shall be performed for installation:
 - The ventilation devices and outlets are operating normally and are not obstructed.
 - Markings and signs on the equipment shall be visible and legible.
- ▶ Upon leakage of the refrigerant, ventilate the room. When the leaked refrigerant is exposed to flame, it may cause generation of toxic gases.
- ▶ Make sure that the work area is safe from flammable substances.
- ▶ To purge air in the refrigerant, be sure to use a vacuum pump.

Installing the unit

- ▶ Note that the refrigerant has no odour.
- ▶ The units are not explosion proof so they must be installed with no risk of explosion.
- ▶ This product contains fluorinated gases that contribute to global greenhouse effect. Accordingly, do not vent gases into the atmosphere.
- ▶ For installation with handling the refrigerant(R-32), use dedicated tools and piping materials.
- ▶ Servicing and installation shall be performed as recommended by the manufacturer. In case other skilled persons are joined for servicing, it shall be carried out under supervision of the person who is competent in handling flammable refrigerants.
- ▶ For servicing the units containing flammable refrigerants, safety checks are required to minimise the risk of ignition.
- ▶ Servicing shall be performed following the controlled procedure to minimize the risk of flammable refrigerant or gases.
- ▶ Do not install where there is a risk of combustible gas leakage.
- ▶ Do not place heat sources.
- ▶ Be cautious not to generate a spark as follows:
 - Do not remove the fuses with power on.
 - Do not disconnect the power plug from the wall outlet with power on.
 - It is recommended to locate the outlet in a high position. Place the cords so that they are not tangled.
- ▶ If the indoor unit is not R-32 compatible, an error signal appears and the unit will not operate.
- ▶ After installation, check for leakage. Toxic gas may be generated and if it comes into contact with an ignition source such as fan heater, stove, and cooker. cylinders, make sure that only the refrigerant recovery cylinders are used.
- ▶ Never directly touch any accidental leaking refrigerant.
- ▶ This could result in severe wounds caused by frostbite.

Preparation of fire extinguisher

- ▶ If a hot work is to be done, an appropriate fire extinguishing equipment should have been available.
- ▶ A dry powder or CO₂ fire extinguisher shall be equipped near the charging area.

Ignition sources free

- ▶ Make sure to store the units in a place without continuously operating ignition sources (for example, open flames, an operating gas appliance or an operating electric heater).
- ▶ The service engineers shall not use any ignition sources with the risk of fire or explosion.
- ▶ Potential ignition sources shall be kept away from the work area where the flammable refrigerant can possibly be released to the surrounding.
- ▶ The work area should be checked to ensure that there are no flammable hazards or ignition risks. The “No Smoking” sign shall be attached.
- ▶ Under no circumstances shall potential sources of ignition be used while in detection of leakage.
- ▶ Make sure that the seals or sealing materials have not degraded.
- ▶ Safe parts are the ones with which the worker can work in a flammable atmosphere. Other parts may result in ignition due to leakage.
- ▶ Replace components only with parts specified by Samsung. Other parts may result in the ignition of refrigerant in the atmosphere from a leak.

Area ventilation

- ▶ Make sure that the work area is well ventilated before performing a hot work.
- ▶ Ventilation shall be made even during the work.
- ▶ The ventilation should safely disperse any released gases and preferably expel them into the atmosphere.
- ▶ Ventilation shall be made even during the work.

Leakage detection methods

- ▶ The leakage detector shall be calibrated in a refrigerant-free area.
- ▶ Make sure that the detector is not a potential source of ignition.
- ▶ The leakage detector shall be set to the LFL (lower flammability limit).
- ▶ The use of detergents containing chlorine shall be avoided for cleaning because the chlorine may react with the refrigerant and corrode the pipings.
- ▶ If leakage is suspected, naked flames shall be removed.
- ▶ If a leakage is found while in brazing, the entire refrigerant shall be recovered from the product or isolated (e.g. using shut-off valves). It shall not be directly released to the environment. Oxygen free nitrogen (OFN) shall be used for purging the system before and during the brazing process.
- ▶ The work area shall be checked with an appropriate refrigerant detector before and during work.
- ▶ Ensure that the leakage detector is appropriate for use with flammable refrigerants.

Labelling

- ▶ The parts shall be labelled to ensure that they have been decommissioned and emptied of refrigerant.
- ▶ The labels shall be dated.
- ▶ Make sure that the labels are affixed on the system to notify it contains flammable refrigerant.

Recovery

- ▶ When removing refrigerant from the system for servicing or decommissioning, it is recommended to remove the entire refrigerant.
- ▶ When transferring refrigerant into cylinders, make sure that only the refrigerant recovery cylinders are used.
- ▶ All cylinders used for the recovered refrigerant shall be labelled.
- ▶ Cylinders shall be equipped with pressure relief valves and shut-off valves in a proper order.
- ▶ The recovery system shall operate normally according to the specified instructions and shall be suitable for refrigerant recovery.
- ▶ In addition, the calibration scales shall operate normally.
- ▶ Hoses shall be equipped with leak-free disconnect couplings.
- ▶ Before starting the recovery, check for the status of the recovery system and sealing state. Consult with the manufacturer if suspected.
- ▶ The recovered refrigerant shall be returned to the supplier in the correct recovery cylinders with the Waste Transfer Note attached.
- ▶ Do not mix refrigerants in the recovery units or cylinders.
- ▶ If compressors or compressor oils are to be removed, make sure that they have been evacuated to the acceptable level to ensure that flammable refrigerant does not remain in the lubricant.
- ▶ The evacuation process shall be performed before sending the compressor to the suppliers.
- ▶ Only the electrical heating to the compressor body is allowed to accelerate the process.
- ▶ Oil shall be drained safely from the system.
- ▶ Never install a motor-driven equipment to prevent ignition.
- ▶ Empty recovery cylinders shall be evacuated and cooled before recovery.

Installing the unit

Installation location requirements

- ▶ The outdoor unit shall be installed in an open space that is always ventilated.
- ▶ The local gas regulations shall be observed.
- ▶ For installation inside a building (this applies either to indoor or outdoor units installed inside) a minimum room floor area of space conditioned is mandatory according to IEC 60335-2-40:2018 (see the reference table into either the indoor or outdoor unit installation manual).
- ▶ To handle, purge, and dispose the refrigerant, or break into the refrigerant circuit, the worker should have a certificate from an industry-accredited authority.
- ▶ Do not install the indoor unit if it has any drainage problem.

Moving the Outdoor Unit by Wire Rope

Fasten the outdoor unit by two 8 m or longer wire ropes as shown at the figure. To prevent from damage or scratches, insert a piece of cloth between the outdoor unit and rope, then move the unit.

- * The appearance of the unit may be different from the picture depending on the model.

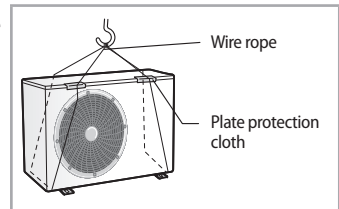

Space requirements for outdoor unit

When installing 1 outdoor unit

(Unit : mm)

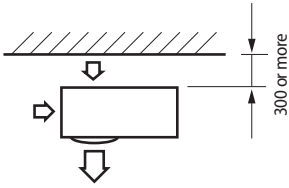

- * When the air outlet is opposite the wall

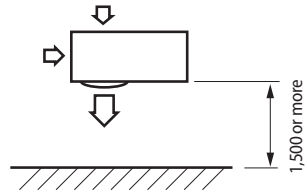

- * When the air outlet is towards the wall

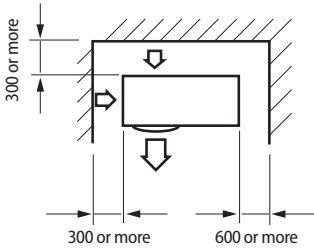

- * When 3 sides of the outdoor unit are blocked by the wall

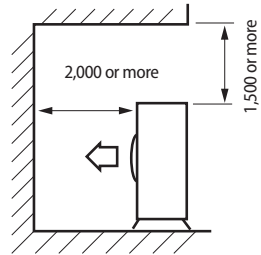

- * The upper part of the outdoor unit and the air outlet is towards the wall

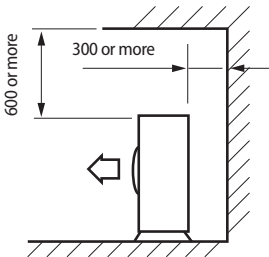

- * The upper part of the outdoor unit and the air outlet is opposite the wall

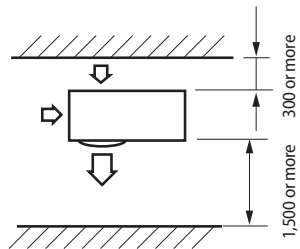

- * When front and rear side of the outdoor unit is towards the wall

Installing the unit

When installing more than 1 outdoor unit

(Unit : mm)

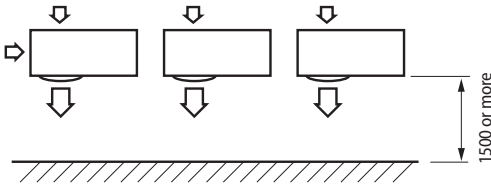

* When the air outlet is towards the wall

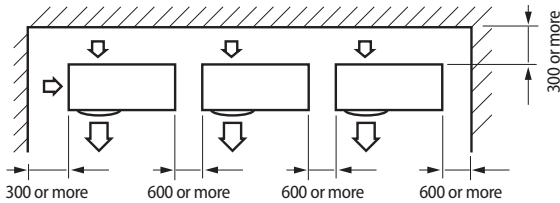

* When 3 sides of the outdoor unit are blocked by the wall

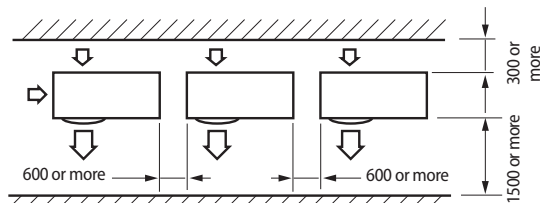

* When front and rear side of the outdoor unit is towards the wall

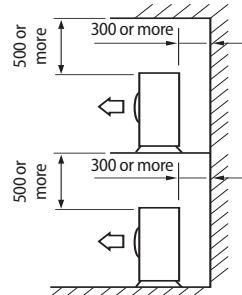

* The upper part of the outdoor unit and the air outlet is opposite the wall

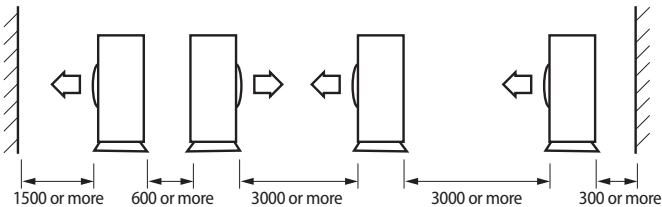

* When front and rear side of the outdoor unit is towards the wall



• The units must be installed according to distances declared, in order to permit accessibility from each side, either to guarantee correct operation of maintenance or repairing products. The unit's parts must be reachable and removable completely under safety condition (for people or things).

Outdoor unit installation

The outdoor unit must be installed on a rigid and stable base to avoid any increase in the noise level and vibration, particularly if the outdoor unit is to be installed in a location exposed to strong winds or at a height, the unit must be fixed to an appropriate support (wall or ground).

- ▶ Fix the outdoor unit with anchor bolts.



- The anchor bolt must be 20 mm or higher from the base surface.



- When tightening the anchor bolt, tighten the rubber washer to prevent the outdoor unit bolt connection part from corroding.
- Make a drain outlet around the base for outdoor unit drainage.
- If the outdoor unit is installed on the roof, you have to check the ceiling strength and waterproof the unit.

(Unit : mm)

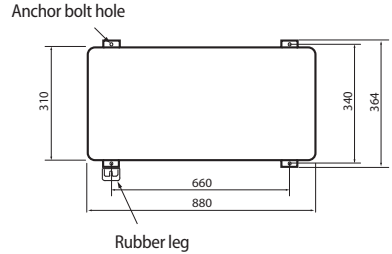

Outdoor unit support

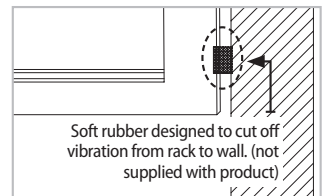
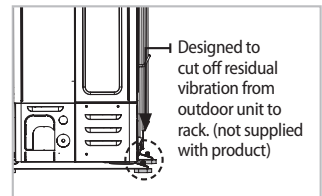
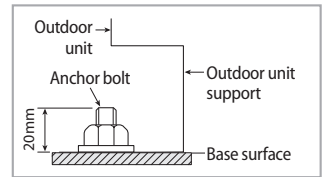
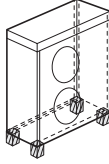
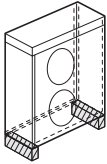

OUTDOOR UNIT INSTALLED ON THE WALL BY RACK

- ▶ Ensure the wall will be able to suspend the weight of rack and outdoor unit ;
- ▶ Install the rack close to the column as much as possible ;
- ▶ Install proper grommet in order to reduce noise and residual vibration transferred by outdoor unit towards wall.



When installing air guide duct

- Check and make sure that screws do not damage the copper pipe.
- Secure air guide duct on guard fan.

Installing the unit

Drain work

• General area

While Air-Water Heat Pump is running in heating mode, Ice can begin accumulate on the surface of condenser. To prevent Ice from growing, system go into De-frost mode and then Ice on the surface changes to water.

Dropped water from condenser shall be eliminated through running drain holes to prevent Ice growing at low temperature.

- ▶ In case there is not enough space for drainage out of the unit, additional drain works are required. Follow the description as below
 - Make space more than 100mm between the bottom of the outdoor unit and the ground for installation of the drain hose.
 - Insert the drain plug into the hole on the bottom of the outdoor unit.
 - Connect the drain hose to the drain plug.
 - Make sure dusts or small branches should not go into the drain hose.

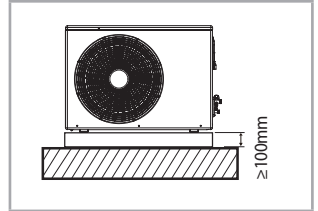

- If drain work is not enough, it can lead to system performance degraation and system damages.

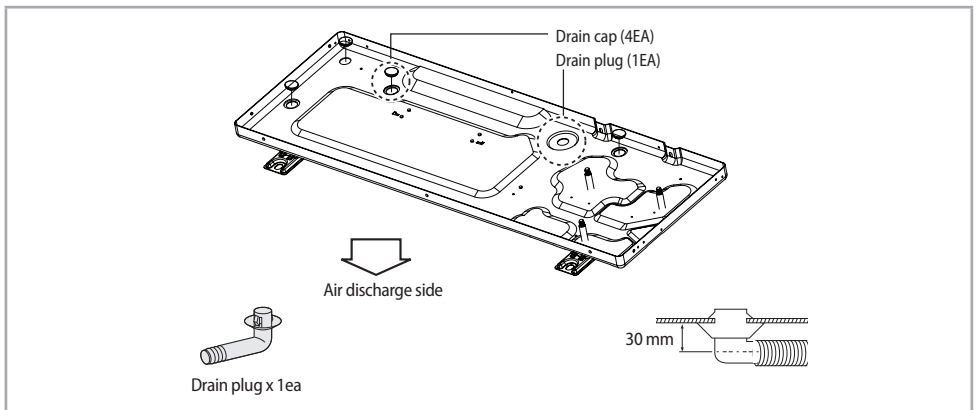

1. Prepare a water drainage channel around the foundation, to drain waste water from around the unit.
2. If the water drainage of the unit is not easy, please build up the unit on a foundation of concrete blocks, etc. (the height of the foundation should be maximum 150 mm).
3. If you install the unit on a frame, please install a waterproof plate within 150 mm of the underside of the unit in order to prevent the invasion of water from the lower direction.
4. When installing the unit in a place frequently exposed to snow, pay special attention to elevate the foundation as high as possible.
5. If you install the unit on a building frame, please install a waterproof plate (field supply) (within 150mm of the underside of the unit) in order to avoid the drain water dripping. (See figure)

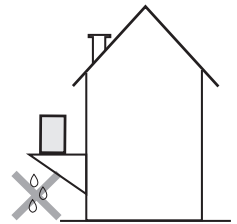

• Heavy snow fall area (Natural drainage)

► When using the air conditioner in the heating mode, ice may accumulate. During de-icing (defrost operation), the condensed water must be drained off safely. For the air conditioner operates well, you must follow the instructions below.

- Make space more than 80mm between the bottom of the outdoor unit and the ground for installation.

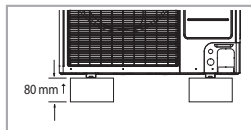

- If the product is installed in a region of heavy snow, allow enough separation distance between the product and the ground.
- When installing the product, make sure that the rack is not placed under the drain hole.
- Ensure that the drained water runs off correctly and safely.



- In areas with heavy snow fall, piled snow could block the air intake. To avoid this incident, install a frame that is higher than estimated snow fall. In addition, install a snow-proof hood to avoid snow from piling on the outdoor unit.
- If ice accumulates on the base, it may cause critical damage to the product. (e.g., a lakeside in a cold area, the seashore, an alpine region, etc.)
- In a heavy snowfall area, do not install the drain plug and drain cap into the outdoor unit. And, it may cause frozen ground. Therefore, take appropriate measures to prevent it.

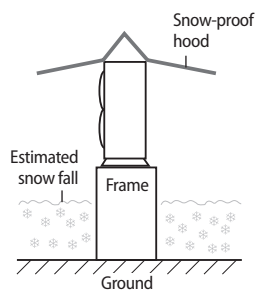

Installing the unit

Selecting a location in cold climates



• When operating the unit in a low outdoor ambient temperature, be sure to follow the instructions described below.

- ▶ To prevent exposure to wind, install the unit with its suction side facing the wall.
- ▶ Never install the unit at a site where the suction side may be exposed directly to wind.
- ▶ To prevent exposure to wind, install a baffle plate on the air discharge side of the unit.
- ▶ In heavy snowfall areas it is very important to select an installation site where the snow will not affect the unit. If lateral snowfall is possible, make sure that the heat exchanger coil is not affected by the snow (If necessary construct a lateral canopy)

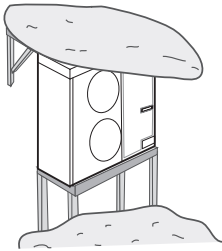

1. Construct a large canopy.
2. Construct a pedestal.
 - Install the unit high enough off the ground to prevent it being buried under snow.

- ▶ The fan inside outdoor unit will operate regularly, as designed, with switch "K6 ON" to prevent from snow accumulating inside outdoor unit. (Refer to page 36)
- ▶ The outdoor unit should be installed with consideration of the direction of strong winds. These can make the unit turn over, so the side of the unit should be set to face the wind, not the front of the unit.

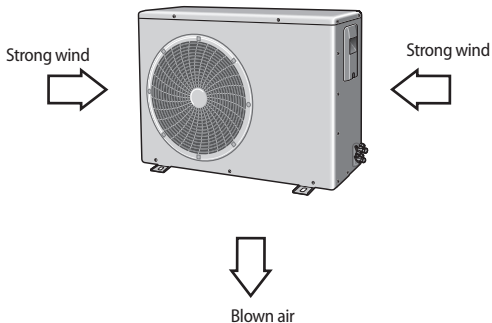

Electrical connections

Overall system configuration

Connection of the power cable (1 phase 2 wires)

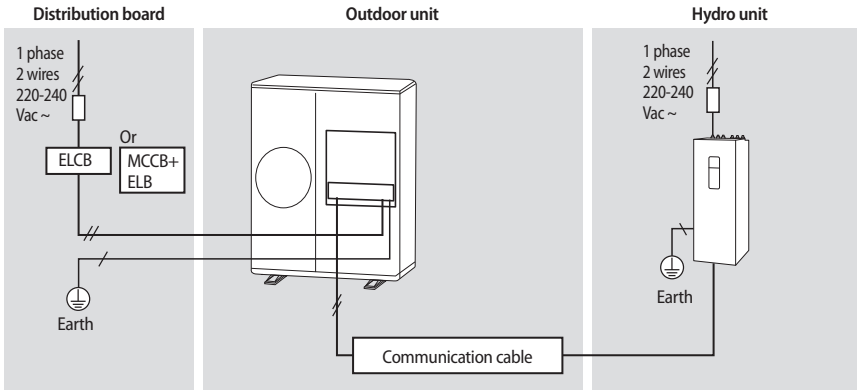

CAUTION

- Install cabinet panel near the outdoor unit for the convenience of service and emergency operation off.
- Make sure to install the circuit breaker with the over-current and electric leakage protection.

Connecting the cable

Power cable specifications

1 phase

Outdoor unit	Rated		Voltage Range		MCA	MFA
	Hz	Volts	Min	Max	Min. Circuit Amps.	Max. Fuse Amps.
AE040RXEDEG	50	220-240	198	264	16.0 A	20.0 A
AE060RXEDEG	50	220-240	198	264	16.0 A	20.0 A

- ▶ The power cable is not supplied with Air to Water Heat pump.
- ▶ Supply cords of parts of appliances for outdoor use shall not be lighter than polychloroprene sheathed flexible cord (Code designation IEC:60245 IEC 57 / CENELEC:H05RN-F)
- ▶ This Equipment complies with IEC 61000-3-12.

Specification of connection cables (common in use)

Power supply	Max/Min(V)	Commuation cable
1Φ, 220-240 Vac, 50 Hz	±10 %	0.75~1.5 mm ² , 2 wires

- ▶ For Power Cable, use the grade H07RN-F or H05RN-F materials.

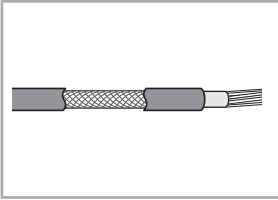

- ▶ Power supply cords of parts of appliances for outdoor use shall not be lighter than polychloroprene sheathed flexible cord. (Code designation IEC:60245 IEC 57 / CENELEC: H05RN-F or IEC:60245 IEC 66 / CENELEC: H07RN-F)
- ▶ When installing the outdoor unit in a computer room or net work room, server room or in the presence of risk of disturbance to the communication cable, use the double shielded (tape aluminium / polyester braid + copper) cable of FROHH2R type.

1-phase terminal block spec

AC power : M4 screw

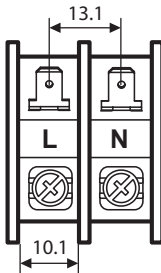

Communication : M4 screw

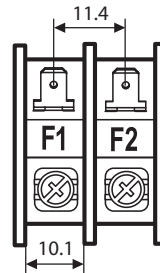

Wiring diagram of power cable

When using ELB/MCCB for 1 phase

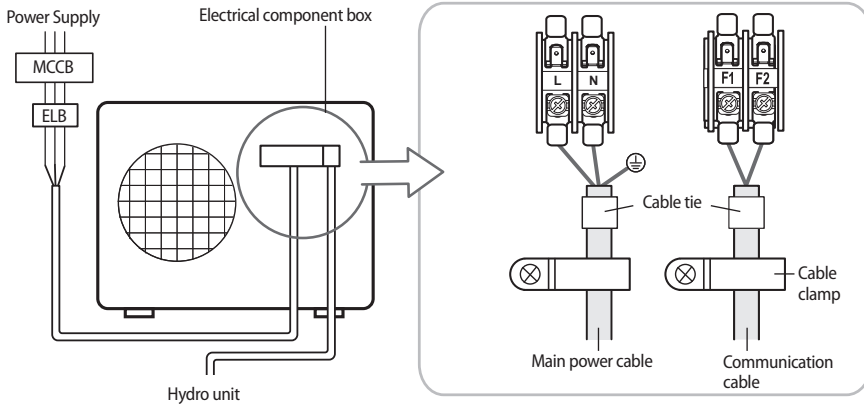

* The appearance of the unit may be different from the picture depending on the model.



CAUTION

- You should connect the power cable into the power cable terminal and fasten it with a clamp.
- The unbalanced power must be maintained within 2 % of supply rating.
 - If the power is unbalanced greatly, it may shorten the life of the condenser. If the unbalanced power is exceeded over 4 % of supply rating, the indoor unit is protected, stopped and the error mode indicates.
- To protect the product from water and possible shock, you should keep the power cable and the connection cord of the indoor and outdoor units within ducts. (with appropriate IP rating and material selection for your application)
- Ensure that main supply connection is made through a switch that disconnects all poles, with contact gap of a least 3 mm.
- Devices disconnected from the power supply should be completely disconnected in the condition of overvoltage category.
- Keep distances of 50 mm or more between power cable and communication cable.

Connecting the cable

1 phase 2 wires

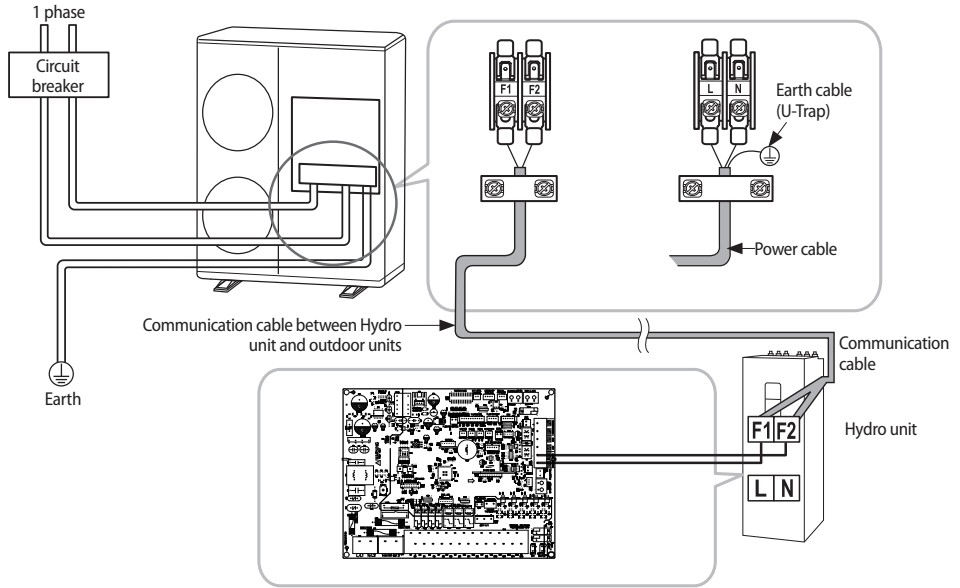

- When removing the outer cover of the power cable, use the appropriate tools to prevent damaging the inner cover.
- Make sure to place the outer cover of the power cable and the communication cable, at least 20 mm into the electrical parts.
- Communication wiring should be done separately from the power cable and other communication cables.

Connecting the power terminal

- ▶ Connect the cables to the terminal board using the compressed ring terminal.
- ▶ Connect the rated cables only.
- ▶ Connect using a wrench which is able to apply the rated torque to the screws.
- ▶ If the terminal is loose, fire may occur caused by arc. If the terminal is connected too firmly, the terminal may be damaged.

Tightening Torque (kgf.cm)	
M4	12~18
M5	20~30



- For the product that uses the R-32 refrigerant, be cautious not to generate a spark by keeping the following requirements:
 - Do not remove the fuses with power on.
 - Do not disconnect the power plug from the wall outlet with power on.
 - It is recommended to locate the outlet in a high position. Place the cords so that they are not tangled.

Installing the earth wire

- ▶ Earthing must be done by your installation specialist for your safety.
- ▶ Use the earth wire by referring to the specification of the electric cable for the outdoor unit.

Earthing the power cable

- ▶ The standard of earthing may vary according to the rated voltage and installation place of the Air to Water Heat Pump.
- ▶ Earth the power cable according to the following.

Power condition	Installation place		
	High humidity	Average humidity	Low humidity
Electrical potential of lower than 150 V		Perform the earthing work 3. <small>Note 1)</small>	Perform the earthing work 3 if possible for your safety. <small>Note 1)</small>
Electrical potential of higher than 150 V		Must perform the earthing work 3. <small>Note 1)</small> (In case of installing circuit breaker)	

* Note 1) Earthing work 3

- Earthing must be done by your installation specialist.
- Check if the earthing resistance is lower than 100Ω. When installing a circuit breaker that can cut the electric circuit in case of a short circuit, the allowable earthing resistance can be 30~500Ω.

- ▶ When using the terminal for earthing only

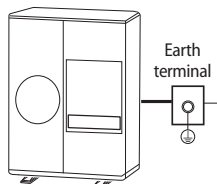



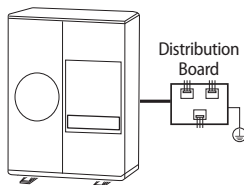

- ▶ When using earthing of the switchboard



Connecting the cable

How to connect your extended power cables

1. Prepare the following tools.

Tools	Crimping pliers	Connection sleeve (mm)	Insulation tape	Contraction tube (mm)
Spec	MH-14	20xØ6.5(HxOD)	Width 19mm	70xØ8.0(LxOD)
Shape				

2. As shown in the figure, peel off the shields from the rubber and wire of the power cable.

- Peel off 20 mm of cable shields from the pre-installed tube.

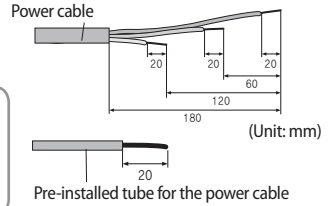

- For information about the power cable specifications for indoor and outdoor units, refer to the installation manual.
- After peeling off cable wires from the pre-installed tube, insert a contraction tube.

3. Insert both sides of core wire of the power cable into the connection sleeve.

► **Method 1**

Push the core wire into the sleeve from both sides.

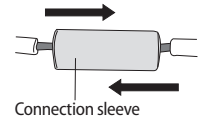

► **Method 2**

Twist the wire cores together and push it into the sleeve.

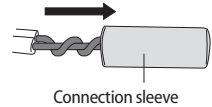

4. Using crimping tool, compress the two points and flip it over and compress another two points in the same location.

- The compression dimension should be 8.0.
 - After compressing it, pull both sides of the wire to make sure it is firmly pressed.

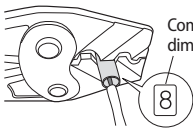

► **Method 1**

Compress it 4 times.

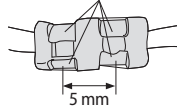

► **Method 2**

Compress it 4 times.

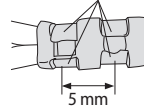

5. Wrap it with the insulation tape twice or more and position your contraction tube in the middle of the insulation tape. Three or more layers of insulation are required.

► **Method 1**

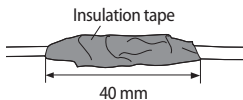

► **Method 2**

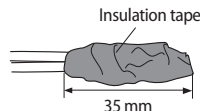

6. Apply heat to the contraction tube to contract it.

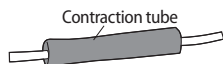

7. After tube contraction work is completed, wrap it with the insulation tape to finish.



CAUTION

- Make sure that the connection parts are not exposed to outside.
- Be sure to use insulation tape and a contraction tube made of approved reinforced insulating materials that have the same level of withstand voltage with the power cable. (Comply with the local regulations on extensions.)

Insulation tape



WARNING

- In case of extending the electric wire, please DO NOT use a round-shaped Pressing socket.
- Incomplete wire connections can cause electric shock or a fire.

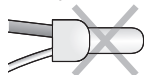

Refrigerant piping work

- ▶ Install the refrigerant pipe within the maximum allowable length, difference in height and length of after the first branch pipe.
- ▶ The pressure of the R-32 is high.
Use only rated refrigerant pipe and follow the installation method.
- ▶ Use clean refrigerant pipe Where there is no harmful ion, oxide, dust, iron content or moisture.
- ▶ Use adequate tools and accessories for R-32.

Manifold gauge	<ul style="list-style-type: none"> • Use manifold gauge only for R-32 to prevent the inflow of foreign substances.
Vacuum pump	<ul style="list-style-type: none"> • Use vacuum pump with check valve to prevent pump oil from flowing backward while the vacuum pump is stopped. • Use the vacuum pump that the vacuum induction is available up to 5Torr. (-100.7kPa)
Flare nut	<ul style="list-style-type: none"> • Use only flare nut supplied with the product.

Allowable length of the refrigerant pipe and the installation examples

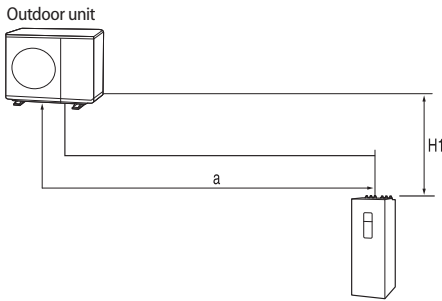

Item		Example		Remarks
Maximum allowable length of pipe	Outdoor unit ~ Hydro unit	Total length	Less than 30 m	$a \leq 30 \text{ m}$
Maximum allowable height	Outdoor unit ~ Hydro unit	Less than 20 m		If outdoor unit is located lower position $H1 \leq 15 \text{ m}$
Additional refrigerant calculation		R=Basic charge + additional charge by the piping length		

Contact the manufacturer if the length should exceed.

- Because your air conditioner contains R-32 refrigerant, make sure that it is installed, operated, and stored it in a room whose floor area is larger than the minimum required floor area specified in the following table:

Minimum required room area (A,m ²)			
m (kg)	Ceiling-mounted	Wall-mounted	Floor-standing
≤ 1.842	No requirement		
1.843	3.64	4.45	28.9
1.9	3.75	4.58	30.7
2.0	3.95	4.83	34.0
2.2	4.34	5.31	41.2
2.4	4.74	5.79	49.0
2.6	5.13	6.39	57.5
2.8	5.53	7.41	66.7
3.0	5.92	8.51	76.6
3.2	6.48	9.68	87.2
3.4	7.32	10.9	98.4
3.6	8.20	12.3	110
3.8	9.14	13.7	123
4.0	10.1	15.1	136
4.2	11.2	16.7	150
4.4	12.3	18.3	165
4.6	13.4	20.0	180
4.8	14.6	21.8	196
5.0	15.8	23.6	213

- m : Total refrigerant charge in the system
 - A : Minimum required floor area
- **IMPORTANT:** it's mandatory to consider either the table above or taking into consideration the local law regarding the minimum living space of the premises.
- Minimum installation height of indoor unit is 0.6 m for floor mounted, 1.8 m for wall, 2.2 m for ceiling.

Refrigerant piping work

Selecting the refrigerant pipe

Outdoor unit capacity (kW)	Liquid side (mm)	Gas side (mm)
AE040RXEDEG	ø6.35	ø15.88
AE060RXEDEG	ø6.35	ø15.88

- ▶ Install refrigerant pipe depending on the outdoor unit capacity.
- ▶ Make sure to use C1220T-1/2H (Semi-hard) pipe for more than Ø19.05 mm. In case of using C1220T-O (Soft) pipe for Ø19.05 mm, pipe may be broken, which can result in an injury.

Outer diameter (mm)	Minimum thickness (mm)	Temper grade
ø 6.35	0.7	C1220T-O
ø 9.52	0.7	
ø12.70	0.8	
ø15.88	1.0	
ø15.88	0.8	C1220T-1/2H OR C1220T-H
ø19.05	0.9	
ø22.23	0.9	

* Temper grade and minimum thickness of the refrigerant pipe

Keeping refrigerant pipe clean and dry

- ▶ To prevent foreign materials or water from entering the pipe, pipes shall be sealed by caps.

Cutting or flaring the pipes

1. Make sure that you prepared the required tools.
 - Pipe cutter, reamer, flaring tool and pipe holder, etc.
2. If you want to shorten the pipe, cut it with a pipe cutter ensuring that the cut edge remains at 90° with the side of the pipe.
 - There are some examples of correct and incorrect cut edges below.

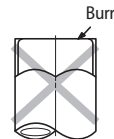
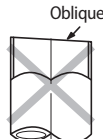
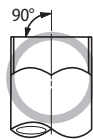
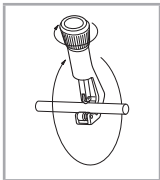

3. To prevent a gas leak, remove all burrs at the cut edge of the pipe with a reamer.



- Face the pipe down while removing the burrs to make sure that burrs do not get in to the pipe.

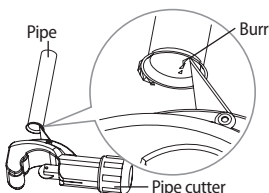

4. Put a flare nut slightly into the pipe and modify the flare.

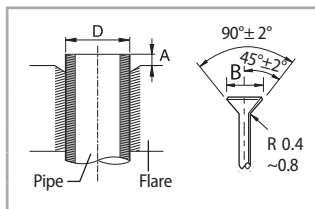

Outer diameter [D(mm)]	Depth [A (mm)]	Flaring Size [B (mm)]
ø 6.35	1.3	8.7~9.1
ø 9.52	1.8	12.8~13.2
ø 12.70	2.0	16.2~16.6
ø 15.88	2.2	19.3~19.7
ø19.05	2.2	23.6~24.0

5. Check that you flared the pipe correctly.
- Below figures shows some examples of incorrectly flared pipes.



Correct



Inclined

Damaged
surface

Cracked

Uneven
thickness

6. Align the pipes to connect them easily. Tighten the flare nuts first with your hands, and then with a torque wrench, applying the following torque:

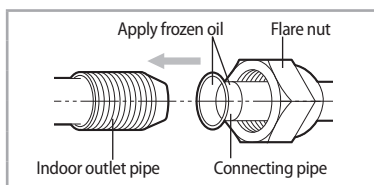

Outer diameter [mm(inch)]	Torque (N·m)
ø 6.35 (1/4")	14~18
ø 9.52 (3/8")	34~42
ø 12.70 (1/2")	49~61
ø 15.88 (5/8")	68~82
ø19.05 (3/4")	100~120



NOTE

- Excessive torque can be cause of gas leakage.



CAUTION

- You must purge with oxygen free nitrogen while brazing.

Refrigerant piping work



CAUTION

- Tighten the nuts to the specified torques. If overtightened, the nuts could be broken so refrigerant may leak.
- Protect or enclose refrigerant tubing to avoid mechanical damage.
- Keep the piping length at a minimum to minimize the additional refrigerant charge due to piping extension.
- When connecting the pipes, make sure that surrounding objects do not interfere with or contact them to prevent refrigerant leakage due to physical damage.
- Make sure that the spaces where the refrigerant pipes are installed comply with national gas regulations.
- Be sure to perform works such as additional refrigerant charging and pipe welding under the conditions of good ventilation.
- Be sure to perform welding and piping works for mechanical connections under the conditions that the refrigerant does not circulate.
- When reconnecting the pipes, make sure to perform flared-jointing newly to prevent refrigerant leakage.
- When working on the refrigerant pipes and the flexible refrigerant connectors, be careful that they are not damaged physically by surrounding objects.
- For installation with handling the R-32 refrigerant, use the special tools for the R-32 refrigerant (manifold gauge, vacuum pump, charging hose, etc.).
- During tests never pressurize the appliances with a pressure higher than the maximum allowable pressure (as indicated on the nameplate of the unit).
- Never directly touch any accidental leaking refrigerant. This could result in severe wounds caused by frostbite.
- Never install a dryer to this unit in order to guarantee its lifetime.
- If you need a pipe longer than specified in piping codes and standards, you must add refrigerant to the pipe. Otherwise, the indoor unit may freeze.
- While removing burrs, put the pipe face down to make sure that the burrs do not get in to the pipe.

Selecting the insulator of the refrigerant pipe

- ▶ According to pipes size, insulate pipes on gas and liquid side by selecting appropriate insulations.
- ▶ Standard condition is under a temperature of 30 °C and a humidity of 85 %. If the units are installed in extreme weather conditions, select the insulator by table below.

Pipe type	Pipe diameter (mm)	Thickness of insulator		Remarks
		Normal (Under 30 °C, 85 %)	High humidity (Over 30 °C, 85 %)	
		EPDM, NBR		
Liquid	ø6.35~ø19.05	9	9	The material shall has heat resistant over 120 °C
	ø12.70~ø19.05	13	13	
Gas	ø6.35	13	19	
	ø9.52	19	25	
	ø12.70			
	ø15.88			
	ø19.05			



CAUTION

- Install the insulation not to be get wider and use the adhesives on the connection part of it to prevent moisture entering.
- Wind the refrigerant pipe with insulation tape if it is exposed to outside sunlight.
- Install the refrigerant pipe respecting that the insulation does not get thinner on the bent part or hanger of pipe.

Insulating the refrigerant pipe

- ▶ You must check if there is a gas leak before completing all the installation process.
- ▶ Use EPDM insulation which meets the following condition.

Item	Unit	Standard	Remarks
Density	g/cm ²	0.048~0.096	KSM 3014-01
Dimension change route by heat	%	-5 or less	
Water absorption rate	g/cm ²	0.005 or less	
Thermal conductivity	kcal/m·h·°C	0.032 or less	KSL 9016-95
Moisture transpiration factor	ng/(m ² ·s·Pa)	15 or less	KSM 3808-03
Moisture transpiration grade	{g/(m ² ·24h)}	15 or less	KSA 1013-01
Formaldehyde dispersion	mg/L	-	KSF 3200-02
Oxygen rate	%	25 or less	ISO 4589-2-96

Refrigerant piping work

Insulating the refrigerant pipe

- ▶ Be sure to insulate the refrigerant pipe, joints and connections with class 'o' material.
- ▶ If you insulate the pipes, the condensed water does not fall from the pipes and the capacity of the Air to Water Heat Pump is improved.
- ▶ Check if there are any insulation cracks on the bent pipe.

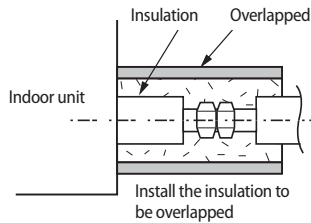
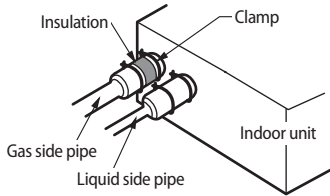

Brazing the Pipe

- ▶ Make sure that there is no moisture inside the pipe.
- ▶ Make sure that there are no foreign materials and impurities in the pipe.

Replacement of Nitrogen gas

1. Use oxygen free nitrogen gas when brazing the pipes as shown in the picture.
2. If you do not use Nitrogen gas when brazing the pipes, oxidation may form in the pipe. It can cause the damage of the compressor and valves.
3. Adjust the flow rate of the replacement with a pressure regulator to maintain 0.05 m³/h or more.
4. Perform brazing of the service valve after protecting the valve.

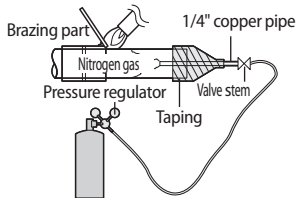

Performing the refrigerant gas leak test

- ▶ Use a manifold gauge for R-32 to prevent the inflow of foreign substances and resist against the internal pressure.
- ▶ Pressure test with dry oxygen free nitrogen only.

Apply pressure to the liquid side pipe and gas side pipe with Nitrogen gas of 4.6 MPa (46.9 kgf/cm²)

If you apply pressure more than 4.6MPa, the pipes may be damaged. Apply pressure using pressure regulator.

Keep it for minimum 24 hours to check if the pressure drops.

After applying Nitrogen gas, check the change of pressure using pressure regulator.

If the pressure drops, check if there is gas leak.

If the pressure is changed, apply soapy water to check the leak. Check the pressure of the Nitrogen gas again.

Maintain 1.0MPa of the pressure before performing vacuum drying and check further gas leak.

After checking first gas leak, maintain 1.0MPa to check further gas leak.

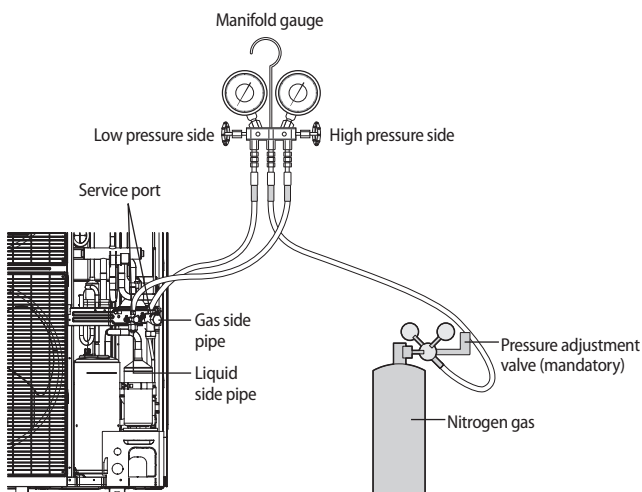

- * Make sure to use a recommended bubble test solution for Gas Leak Test. Soap water could cause cracking of the flare nuts or lead to corrosion of flared joints.



- You may get injured when the joint on the high pressure side detaches and the gas comes in contact with your body. Make sure to tighten the joint to prevent such accidents.

Refrigerant piping work

Vacuum drying

- ▶ Use the tools for R-32 only to prevent the inflow of foreign substances and resist against the internal pressure.
- ▶ Use the vacuum pump with the check valve to prevent pump oil from flowing backward while the vacuum pump is stopped suddenly.
- ▶ Use the vacuum pump that can be vacuumed up to 666.6Pa(5 mmHg).
- ▶ Close the service valve of the liquid side pipe, gas side pipe completely when performing air tightening test or vacuum drying.

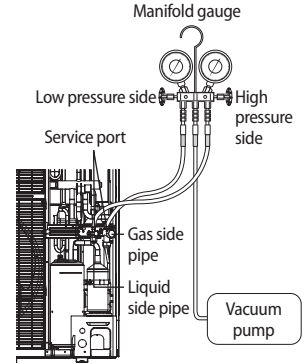

Connect the manifold gauge to the liquid pipe and gas pipe.

Vacuum the liquid pipe and gas pipe using the vacuum pump.

Make sure to install check valve to prevent pump oil from flowing into the pipe.

Vacuum those pipes for more than 2 hours and 30 minutes.

The time of vacuum drying may differ depending on the length of the pipe or outdoor temperature. Perform vacuum drying for at least 2 hours and 30 minutes.

Close the valve after checking the vacuum gauge pressure has reached at -100.7 kPa (gauge pressure).

Check the vacuum pressure using the vacuum gauge.

Check whether the pressure is maintained as -100.7 kPa (gauge pressure), 5 torr. for an hour.

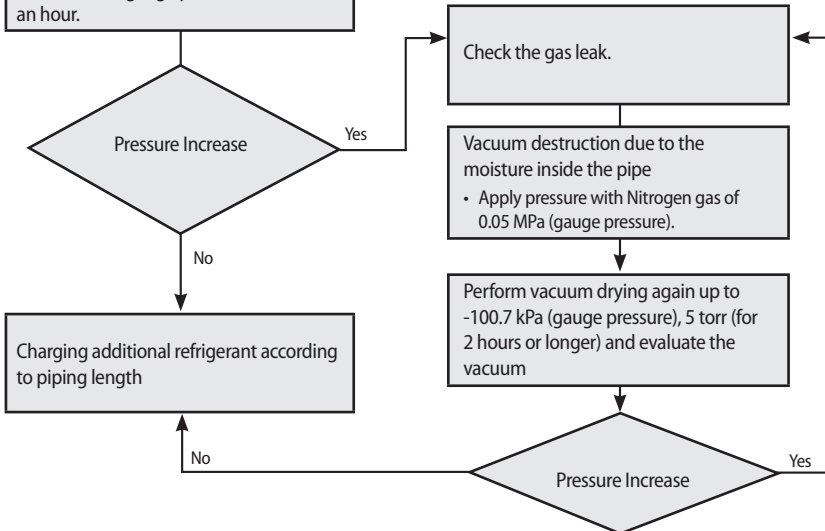

• If the pressure rises in an hour, either water remains inside the pipe, or there will be a leak.

Selecting additional refrigerant charge

* Basic charge

The basic amount of refrigerant for outdoor unit charged in factory is:

Outdoor unit (Series)	Factory charge(kg)
AE040RXEDEG	1.2
AE060RXEDEG	

- * Charge additional refrigerant according to the total length of the pipe.
Each factory charging values are determined according to basic pipe length 15 m.
When extra pipe length are required, additional charging works must be implemented as describes below.

Refrigerant Charging

- * Additional charging amount is determined based on liquid pipe specifications.

Outdoor unit of liquid	ø6.35
Additional charging (g)	20 g/m

$$\text{Additional Charge(g)} = (L1-15) \times 20$$



NOTE

- L1: Total length of liquid pipe Ø 6.35(m)_Model : AE040/060RXEDEG

Ex) Total length of liquid pipe =20 m

$$\text{Ø } 6.35 = (20\text{m}-15\text{m}) \times 20\text{g/m} = 100 \text{ g (Model : AE040/060RXEDEG)}$$

Precautions on adding the R-32 refrigerant

In addition to the conventional charging procedure, the following requirements shall be kept.

- ▶ Make sure that contamination by other refrigerants does not occur for charging.
- ▶ To minimize the amount of refrigerant, keep the hoses and lines as short as possible.
- ▶ The cylinders shall be kept upright.
- ▶ Make sure that the refrigeration system is earthed before charging.
- ▶ Label the system after charging, if necessary.
- ▶ Extreme care is required not to overcharge the system.
- ▶ Before recharging, the pressure shall be checked with nitrogen blowing.
- ▶ After charging, check for leakage before commissioning.
- ▶ Be sure to check for leakage before leaving the work area.

Refrigerant piping work

Charging refrigerant

- ▶ Measure the quantity of the refrigerant according to the length of the liquid side pipe. Add quantity of the refrigerant using a scale.

Important information: regulation regarding the refrigerant used

This product contains fluorinated greenhouse gases. Do not vent gases into the atmosphere.



- Inform user if the system contains 5 tCO₂e or more of fluorinated greenhouse gases. In this case, it must be checked for leakage at least once every 12 months, according to regulation No. 517/2014. This activity must be covered by qualified personnel only. In the case of the situation above, the installer (or authorized person with responsibility for final check) must provide a maintenance book, with all the information recorded, according to REGULATION (EU) No. 517/2014 OF THE EUROPEAN PARLIAMENT AND OF THE COUNCIL of 16 April 2014 on fluorinated greenhouse gases.

Please fill in the following indelible ink on the refrigerant charge label supplied with this product on and on this manual.

- ▶ ① The factory refrigerant charge of the product.
- ▶ ② The additional refrigerant amount charged in the field.
- ▶ ①+② The total refrigerant charge.

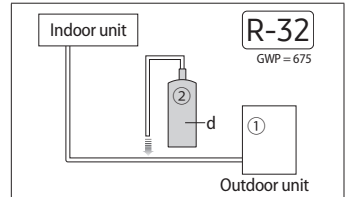

- a. Factory refrigerant charge of the product: See unit name plate.
- b. Additional refrigerant amount charged in the field. (Refer to the above information for the quantity of refrigerant replenishment.)
- c. Total refrigerant charge.
- d. Refrigerant cylinder and manifold for charging.

Unit	kg	tCO ₂ e
①, a		
②, b		
① + ②, c		

Refrigerant type	GWP value
R-32	675

- * GWP: Global Warming Potential
- * Calculating tCO₂e: kg x GWP/1000

- ▶ Before charging, check whether the refrigerant cylinder has a siphon attached or not and position the cylinder accordingly.

Charging using a cylinder with a siphon attached

Charge the liquid refrigerant with the cylinder in upright position.

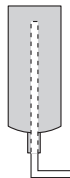

Charging using a cylinder without a siphon attached

Charge the liquid refrigerant with the cylinder in up-side-down position.



- The filled-out label must be adhered in the proximity of the product charging port (e.g. onto the inside of the stop valve cover).
- Make sure that the total refrigerant charge does not exceed (A), the maximum refrigerant charge, which is calculated in the following formula: Maximum refrigerant charge (A) = factory refrigerant charge (B) + maximum additional refrigerant charge due to piping extension (C).
- Here below, the summary table with refrigerant charge limits for each products.

Model	A	B	C	(Unit : g)
AE040/060RXEDEC	1,500	1,200	300	

Adding refrigerant

- ▶ Measure the quantity of the refrigerant depending on the length of the liquid side pipe. Add fixed quantity of the refrigerant using a scale.

* Adding refrigerants in cooling conditions

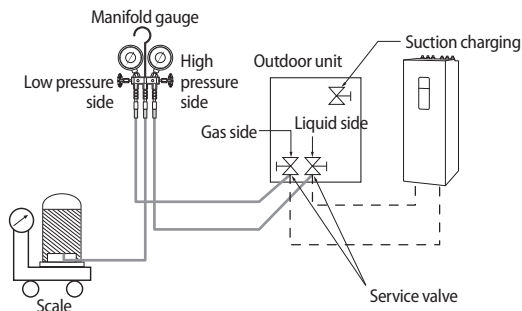

* Adding refrigerants in heating conditions

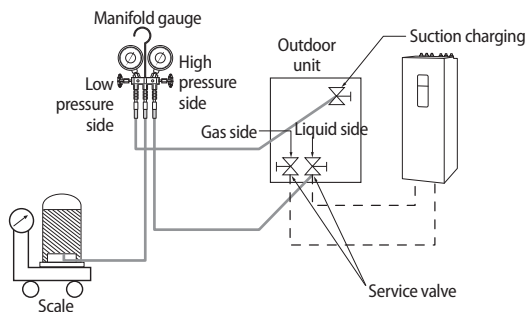

- ▶ Connect the manifold gauge and purge the manifold gauge.
- ▶ Open the manifold gauge valve of the liquid side service valve and add the liquid refrigerant.
- ▶ If you cannot fully recharge the additional refrigerant while the outdoor unit is stopped, use the key on the outdoor unit PCB to recharge the remaining refrigerant.
- ▶ Adding the cooling refrigerant
 - 1) Press the function key for adding refrigerant in cooling mode.
 - 2) After 20 minutes of operation, open the valve on gas side.
 - 3) Open the valve for low pressure side on the manifold gauge to recharge the remaining refrigerant.

Refrigerant piping work

- ▶ Adding the heating refrigerant
 - 1) When recharging the heating refrigerant, connect the low pressure pipe from manifold gage to the suction charging port.
 - 2) Press the function key for adding refrigerant in heating mode.
 - 3) After 20 minutes of operation, open the valve on suction charge port.
 - 4) Open the valve for low pressure side on the manifold gage to recharge the remaining refrigerant.



• Open the gas side and liquid side service valve completely after charging the refrigerant. (If you operate the Air to Water Heat Pump with the service valve closed, the important parts may be damaged.)

To close the valve stem

1. Open the cap and turn the valve stem clockwise by using a hexagonal wrench.

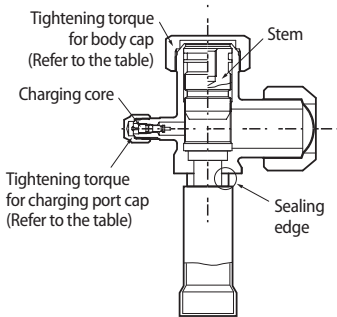

Outer Diameter (mm)	Tightening torque (N·m)		Operating torque (N·m)
	Body cap	Charging port cap	Stem
ø6.35	20 ~ 25	10 ~ 12	Max 5
ø9.52			Max 5
ø12.70			Max 5
ø15.88			Max 5
ø19.05			Max 12

* 1 N·m = 10 kgf·cm

2. Tighten the valve stem until it reached the sealing edge.



• Do not apply excessive force to the valve stem and always use special instruments. Otherwise, the contact surface between valve stem and sealing edge can be damaged and refrigerant can leak through this damaged surface.

• If refrigerant would leak, turn the valve stem back by half and tighten the valve stem again, then check the leakage. If there is no leakage any more, tighten the valve stem entirely.

3. Tighten the cap securely.

To open the valve stem

1. Remove the cap.
2. Turn the valve stem counterclockwise by using a hexagonal wrench.
3. Turn the valve stem until it is stopped.
4. Tighten the cap securely.



• When you use the service port, always use a charging hose, too.

• Check the leakage of refrigerant gas after tightening the cap.

• Must use a spanner and wrench when you open/tighten the valve stem.

Checking correct grounding

If the power distribution circuit does not have a grounding or the grounding does not comply with specifications, an grounding electrode must be installed. The corresponding accessories are not supplied with the Air to Water Heat pump.

1. Select an grounding electrode that complies with the specifications given in the illustration.

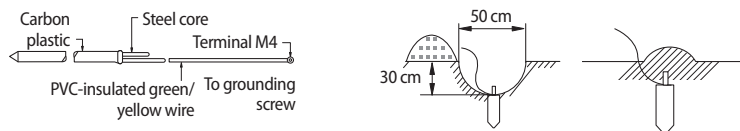

2. Connect the flexible hose to the flexible hose port.
 - ▶ In damp hard soil rather than loose sandy or gravel soil that has a higher grounding resistance.
 - ▶ Away from underground structures or facilities, such as gas pipes, water pipes, telephone lines and underground cables.
 - ▶ At least two metres away from a lightning conductor grounding electrode and its cable.



NOTE

- The grounding wire for the telephone line cannot be used to ground the Air to Water Heat pump.

3. Finish wrapping insulating tape around the rest of the pipes leading to the outdoor unit.
4. Install a green/yellow coloured grounding wire :
 - ▶ If the grounding wire is too short, connect an extension lead, in a mechanical way and wrapping it with insulating tape (do not bury the connection).
 - ▶ Secure the grounding wire in position with staples.



NOTE

- If the grounding electrode is installed in an area of heavy traffic, its wire must be connected securely.

5. Carefully check the installation, by measuring the grounding resistance with a ground resistance tester. If the resistance is above required level, drive the electrode deeper into the ground or increase the number of grounding electrodes.
6. Connect the grounding wire to the electrical component box inside of the outdoor unit.

Setting the option switch and function of the keys

Testing operations

1. Check the power supply between the outdoor unit and the auxiliary circuit breaker.
 - 1 phase power supply : L, N
2. Check that you have connected the power and communication cables correctly. (If the power cable and communication cables one mixed up or connected incorrectly, the PCB will be damaged.)

Setting the option switch and function of the keys

3. Press K1 or K2 on the outdoor unit PCB to run the test mode and stop.

KEY	KEY operation	7-segment display
K1	Press once : Heating test run	"F" "1" "BLANK" "BLANK"
	Press twice : Defrost test run	"F" "3" "BLANK" "BLANK"
	Press 3times : Finishing test mode	-
K2	Press once : Cooling test run (Heating Only : skip)	"F" "2" "BLANK" "BLANK"
	Press twice : Output signal test run	"F" "4" "BLANK" "BLANK"
	Press 3 times : Finishing test mode	-
K3	Reset	-
K4	View mode	Refer to View mode display

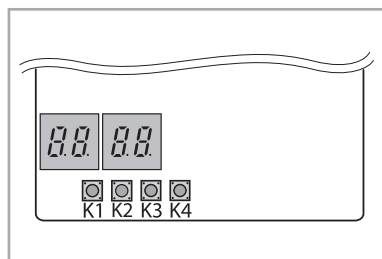
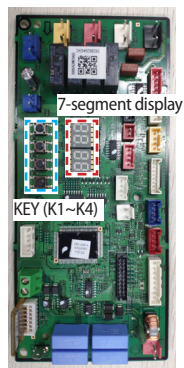

4. View Mode : When the K4 switch is pressed, you can see information about our system state as below.

Number of press	Display contents	Display				Units
		Segment 1	Segment 2	Segment 3	Segment 4	
0	Communication State	10s digit of Tx	1s digit of Tx	10s digit of Rx	1s digit of Rx	-
1	Order frequency	1	100s digit	10s digit	1s digit	Hz
2	Current frequency	2	100s digit	10s digit	1s digit	Hz
3	Pump output	3	100s digit	10s digit	1s digit	%
4	Outdoor air sensor	4	+/-	10s digit	1s digit	°C
5	Discharge sensor	5	100s digit	10s digit	1s digit	°C
6	Eva in sensor	6	+/-	10s digit	1s digit	°C
7	Inlet water sensor	7	+/-	10s digit	1s digit	°C
8	Outlet water sensor	8	+/-	10s digit	1s digit	°C
9	Cond sensor	9	+/-	10s digit	1s digit	°C
10	Current	A	10s digit	1s digit	First decimal	A
11	Fan RPM	B	1000s digit	100s digit	10s digit	rpm
12	Target discharge temperature	C	100s digit	10s digit	1s digit	°C
13	EEV	D	1000s digit	100s digit	10s digit	step

Number of press	Display contents	Display				Units
		Segment 1	Segment 2	Segment 3	Segment 4	
14	Protective control	E	0 : Cooling 1 : Heating	Protective control 0 : No protective control 1 : Freezing 2 : Defrosting 3 : Over-load 4 : Discharge 5 : Total current	Frequency status 0 : Normal 1 : Hold 2 : Down 3 : Up_limit 4 : Down_limit	-
15	IPM temp.	F	+/-	10s digit	1s digit	°C
long-1	Main Micom version	Year(Dec)	Month(Hex)	Day(two digit)	Day(One digit)	-
long-1 and 1	Inverter Micom version	Year(Dec)	Month(Hex)	Day(two digit)	Day(One digit)	-
long-1 and 2	EEPROM version	Year(Dec)	Month(Hex)	Day(two digit)	Day(One digit)	-

5. Key function setting

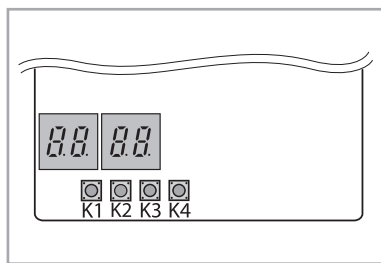

Setting the option switch and function of the keys

Setting the option

1. Press and hold K2 to enter the option setting. (Only available when the operation is stopped)
 - If you enter the option setting, display will show the following.

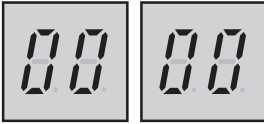

- Seg1 and Seg2 will display the number for selected option.
 - Seg3 and Seg4 will display the number for set value of the selected option.
2. If you have entered option setting, you can shortly press the K1 switch to adjust the value of the Seg1, Seg2 and select the desired option.

Example)

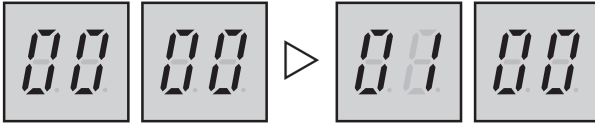

3. If you have selected desired option, you can shortly press the K2 switch to adjust the value of the Seg3, Seg4 and change the function for the selected option.

Example)

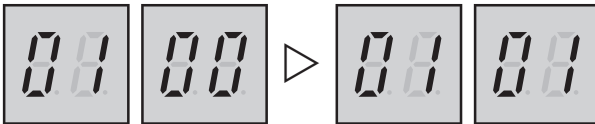

4. After selecting the function for options, press and hold the K2 switch for 2 seconds. Edited value of the option will be saved when entire segments blinks and tracking mode begins.



• Edited option will not be saved if you do not end the option setting as explained in above instruction.

- * While you are setting the option, you may press and hold the K1 button to reset the value to previous setting.
- * If you want to restore the setting to factory default, press and hold the K4 button while you are in the option setting mode.
 - If you press and hold the K4 button, setting will be restored to factory default but it doesn't mean that restored setting is saved. Press and hold the K2 button. When the segments shows that tracking mode is in progress, setting will be saved.

Option	Input unit	SEG1	SEG2	SEG3	SEG4	Function of the option
Channel address	Main	0	0	A 0	U 0	Automatic address setting (default) Manual address setting (0 to 15)
Base heater	Main	0	1	0 0	0 1	Enabled (default) Disabled
Operation mode	Main	0	2	0 0	0 1	Heat Pump (default) Heating Only
Snow accumulation prevention control	Main	0	3	0 0	0 1	Disabled (default) Enabled
Silent mode	Main	0	4	0 0 0 0 0	0 1 2 3 4	Manual Silent mode (-3 dB) Manual Silent mode * 0.9 (-5 dB) Manual Silent mode * 0.75 (-7 dB) Manual Silent mode (-3 dB) Low-noise Silent mode (default)
Energy saving mode	Main	0	5	0 0	0 1	Disabled (default) Enabled

Pump down procedure

Objective of pump down

For product repairs and indoor unit relocation, pump down operation must be done recover the refrigerant into the outdoor unit.

Cautions when performing pump down

- ▶ Product limits amount of refrigerant in the outdoor unit due to slim design.
- ▶ Collect the majority of the refrigerant in the system in an empty refrigerant vessel and perform a pump down operation with remaining refrigerant. Maximum amount of refrigerant is 1.8Kg.
- ▶ If the amount of refrigerant exceeds maximum allowable limit, increased pressure may cause compressor trip or a burn out.

Cautions when performing pump down

1. Close the manifold gauge.
2. Close the liquid side service valve.
3. Set the unit to the Cooling Test mode by pushing K2 button 1 time.
4. Observe low pressure side using manifold gauge when the compressor operating.
5. When the pressure gauge indicates "0" turn the low pressure side valve counter clockwise to close.
6. Stop operation of the unit by pushing K3 button.
7. Close the each cap of valve.



- Use a transfer cylinder when recovering refrigerant to be reused. Using modified refrigerant vessel may cause explosion and cause damage or personal injury.



NOTE

Relocation of the Air to water heat pump

- Refer to this procedure when the unit is relocated.
- Carry out the pump down procedure. (Refer to the details of 'pump down'.)
- Collecting refrigerant may be hard, since multi type products exceeds allowable charging amount of refrigerant in the outdoor unit to support long piping. (Refer to page 36.)
- Remove the power cord.
- Disconnect the assembly cable from the indoor and outdoor units.
- Remove the flare nut connecting the indoor unit and the pipe.
- At this time, cover the pipe of the indoor unit and the other pipe using a cap or vinyl plug to avoid foreign material entering.
- Disconnect the pipe connected to the outdoor unit. At this time, cover the valve of the outdoor unit and the other pipe using a cap or vinyl plug to avoid foreign material entering.
- Make sure you do not bend the connection pipes in the middle and store together with the cables.
- Move the indoor and outdoor units to a new location.
- Remove the mounting plate for the indoor unit and move it to a new location.



NOTE

- Before relocating the units, be sure to thoroughly read Recovery on page page 11.
- When recharging R-32 refrigerant after it has been completely removed, be sure to charge only the factory refrigerant amount.
- When vacuuming the product, be sure to proceed for at least 1 hour.
- Be sure to use an electronic balance when measuring the amount of refrigerant, and make sure that only the specified amount is charged.



- If more than the amount of refrigerant specified on the label is charged, a fire may occur when the refrigerant leaks.

Collecting refrigerant in refrigerant vessel before pump down operation

If the amount of refrigerant in the system exceeded the maximum allowable limit, reduce the amount of the refrigerant by following the below instruction before pump down operation.

1. Prepare an exclusive rechargeable refrigerant vessel, scale and a manifold gauge.
2. Check the amount of refrigerant in the entire system.
3. Connect a refrigerant vessel to an outdoor unit and operated about 50 % of the indoor unit in cooling mode.
4. After 10 minutes of cooling operation, check the pressure on high pressure side with the manifold gauge. If the pressure on the high pressure side is over 3.0 MPa (30.59 kgf/cm²), reduce the number of operating indoor unit to decrease the pressure below 3.0 MPa (30.59 kgf/cm²).
5. When the pressure becomes lower than 3.0 MPa (30.59 kgf/cm²) open the manifold gauge valve ② which is connected to a liquid side. Then, open the valve on the refrigerant vessel for the refrigerant to flow from the liquid side pipe to a vessel.
6. Check the weight difference with the scale. When desired amount of the refrigerant is collected into the vessel, close the valve and remove the manifold gauge.
7. Make sure that the amount of the refrigerant in the vessel is about 50 % of the entire system.
8. Measure the amount of refrigerant correctly to not exceed amount of collected refrigerant.

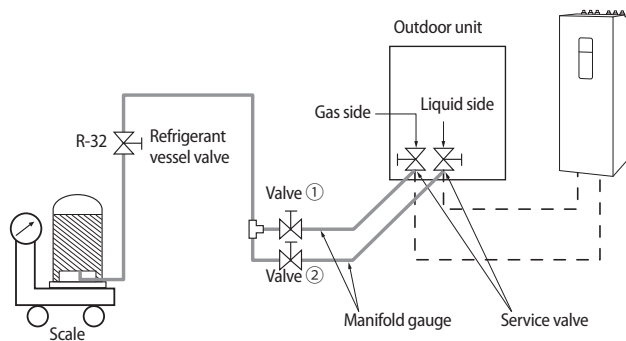

Completing the installation

► Check the following after completing the installation.

Installation	Outdoor unit	<ul style="list-style-type: none">• Check the external surface and the inside of the outdoor unit.• Is there any possibility of short circuit?• Is the place well-ventilated and ensures space for service?• Is the outdoor unit fixed securely?
	Indoor unit	<ul style="list-style-type: none">• Check the external surface and the inside of the indoor unit.• Is the place well-ventilated and ensures space for service?• Check if the center of the indoor unit is ensured and it is installed horizontally.
Adding refrigerant		<ul style="list-style-type: none">• Are the length and the difference between the refrigerant pipes within the allowable range?• Is the pipe properly insulated?• Is the quantity of the additional refrigerant correctly weighed in?
Installing the drain pipe		<ul style="list-style-type: none">• Check the drain pipe of the outdoor unit and the indoor unit.• Have you completed the drain test?• Is the drain pipe properly insulated?
Installing the wiring		<ul style="list-style-type: none">• Have you performed the earthing work 3 to the outdoor unit?• Is 2-core cable used?• Is the length of the wire is in the limited range?• Is the wiring route correct?

Final checks and trial operation

Inspection before test operation

1. Check the power cable and communication cable of the indoor and outdoor unit.
2. Check the power supply between the outdoor unit and the cabinet panel.
 - Check the 220-240 Vac~ / 380-415 Vac~ with the voltage meter.
3. Once the outdoor unit is turned on, it performs the tracking to check the connected indoor unit and options.

Test operation

1. **Run the unit by KEY MODE or controller.**
 - Inspect the compressor sound during the initial operation. If roaring sound is heard, stop operation.
2. **Check the indoor and outdoor units' running status.**
 - Indoor and outdoor unit's abnormal running noise.
 - Proper drainage from indoor unit in cooling mode.
 - Check detail running status using S-NET program.
3. **Finish test.**
4. **Explain to the customer how to use the Air to Water Heat Pump following the user's manual.**

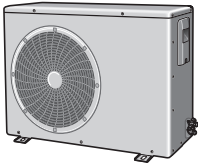

Trouble shooting



- Incorrect handling of thermostat, safety valve or other valves may lead to tank rupture. When servicing the unit follow instructions carefully:
- Always turn off main power supply when water supply is being shut off.
- Test the free operation of the safety valve regularly by opening the valve ensuring the water flows freely.
- Electrical connection and all servicing of the electrical components should only be carried out by an authorized electrician.
- Fitting and all servicing of plumbing fixtures should only be carried out by an authorized installer.
- When replacing the thermostat, safety valve or any other valve or part supplied with this unit, use only approved parts of the same specification.

Error codes

If the unit has some problems and does not work normally, error code is shown on the OUTDOOR UNIT main PBA or LCD of the wired remote controller.

Display	Explanation	Error Source
101	Hydro Unit / Outdoor Unit communication connection error	Hydro Unit
120	Short- or open-circuit error of the room temperature sensor of the Zone 2 indoor unit (detected only when the room thermostat is used)	Hydro Unit
121	Short- or open-circuit error of the room temperature sensor of the Zone 1 indoor unit (detected only when the room thermostat is used)	Hydro Unit
122	EVA Inlet temp sensor SHORT or OPEN	Hydro Unit
123	EVA Outlet temp sensor SHORT or OPEN	Hydro Unit
162	EEPROM Error	Hydro Unit
198	Error of Terminal Block's Thermal Fuse(Open)	Hydro Unit
201	Hydro Unit / Outdoor Unit communication error(Matching error)	Hydro Unit/Outdoor Unit
202	Hydro Unit / Outdoor Unit communication error(3 min)	Hydro Unit/Outdoor Unit
203	Communication error between INVERTER and MAIN MICOM (4 min)	Outdoor Unit
221	Outdoor Unit air temperature sensor error	Outdoor Unit
231	Condenser temperature sensor error	Outdoor Unit
251	Discharge temperature sensor error	Outdoor Unit
320	OLP sensor error	Outdoor Unit
403	Detection of freezing (During cooling operation)	Outdoor Unit
404	Protection of Outdoor Unit when it is overload (during Safety Start, Normal operation state)	Outdoor Unit
407	Comp down due to high pressure	Outdoor Unit
416	Discharge of a compressor is overheated	Outdoor Unit

Display	Explanation	Error Source
419	OUTDOOR UNIT EEV operation error	Outdoor Unit
425	Power source line missing error (only for 3-phase model)	Outdoor Unit
440	Heating operation blocked (outdoor temperature over 35 °C)	Outdoor Unit
441	Cooling operation blocked (outdoor temperature under 9 °C)	Outdoor Unit
458	OUTDOOR UNIT fan1 error	Outdoor Unit
461	[Inverter] Compressor startup error	Outdoor Unit
462	[Inverter] Total current error/PFC over current error	Outdoor Unit
463	OLP is overheated	Outdoor Unit
464	[Inverter] IPM over current error	Outdoor Unit
465	Compressor overload error	Outdoor Unit
466	DC LINK over/low voltage error	Outdoor Unit
467	[Inverter] Compressor rotation error	Outdoor Unit
468	[Inverter] Current sensor error	Outdoor Unit
469	[Inverter] DC LINK voltage sensor error	Outdoor Unit
470	Outdoor unit EEPROM Read/Write Error	Outdoor Unit
471	Outdoor unit EEPROM Read/Write Error(OTP error)	Outdoor Unit
474	IPM(IGBT Module) or PFCM temperature sensor Error	Outdoor Unit
475	Outdoor Unit Fan2 error	Outdoor Unit
484	PFC Overload Error	Outdoor Unit
485	Input current sensor error	Outdoor Unit
500	IPM is overheated	Outdoor Unit
554	Gas leak error	Outdoor Unit
590	Inverter EEPROM Checksum error	Outdoor Unit
601	Communication error between the Hydro Unit and wired remote controller	Hydro Unit
604	Communication tracking error between the Hydro Unit and wired remote controller	Hydro Unit
653	Wired remote controller temp sensor SHORT or OPEN	Hydro Unit, Wired Remote Controller
654	Memory(EEPROM) Read/Write Error(Wired remote Controller data error)	Hydro Unit, Wired Remote Controller
899	Short- or open-circuit error of the Zone 1 water-out temperature sensor	Hydro Unit
900	Short- or open-circuit error of the Zone 2 water-out temperature sensor	Hydro Unit
901	Water inlet (PHE) temperature sensor error(open/short)	Hydro Unit
902	Water outlet (PHE) temperature sensor error(open/short)	Hydro Unit
903	Water outlet (backup heater) temperature sensor error	Hydro Unit
904	DHW tank temperature sensor error	Hydro Unit

Error codes

Display	Explanation	Error Source
906	Refrigerant gas inlet (PHE) temperature sensor (open/short)	Outdoor Unit
911	Low flow rate error • in case of low flow rate in 30 sec during water pump signals is ON(Starting) • in case of low flow rate in 15 sec during water pump signals is ON(After starting)	Hydro Unit
912	Normal flow rate error • in case of normal flow rate in 10min during water pump signal is OFF	Hydro Unit
916	Mixing valve sensor error	Hydro Unit
919	Error that the set temperature for disinfection operation is not reached, or, after reaching, the temperature fails to continue for the requested time	Hydro Unit

SAMSUNG ELECTRONICS CO., LTD.

SUZHOU SAMSUNG ELECTRONICS CO., LTD.

No.501, Suhong East Road, Suzhou Industrial Park, Jiangsu Province, P.R.China

SUZHOU SAMSUNG ELECTRONICS CO., LTD. EXPORT.

No.218, Jiepu Road, Suzhou Industry Park, Jiangsu Province, P.R.China

Samsung Electronics

Service Department

PO Box 12987, Blackrock, Co. Dublin. Ireland

or

Blackbushe Business Park, Yateley, GU46 6GG. UK



This appliance is filled with R-32.